



TPC



INNOVATION • RELIABILITY • QUALITY

2024 Catalog U.S.A



tpcdental.com

OUR VISION

A Perferred Company

To create a quality environment where people can work together to provide simple, cost effective creative solutions for the betterment of dentistry.

OUR MISSION

Continuous Improvement

We will manufacture innovative, high quality and cost effective dental products that enable distribution partners, dentists, hygienists, teaching institutions and government organizations throughout the world to perform efficient quality dental care. TPC provides innovative solutions and quality equipment that enables dental professionals to work together for the benefit of dentistry.

TABLE OF CONTENTS

Our Vision & Our Mission	Inside Front Cover
Terms & Conditions	3
Chairs & Delivery Units	4-41
Air Compressors / Wet Ring Vacuum Systems	42-44
Portable Dental Systems	45-51
Stools & X-Ray Chairs	52-55
Operatory Lights	56-60
Mobile Cabinets	61
Imaging Products & Accessories	62-70
Dental Handpiece & Parts	71-84
Handpiece Cleaning & Lubrication Systems	85
Curing & Bleaching	86-94
Scaling Products & Accessories	95-101
Ultrasonic Bath	102-105
Digital Amalgamator	106
Micro Motor & Handpiece	107
PPE	108-112
Disposable Micro Applicators	113
Disposable Air / Water Syringes	114
Disposable Prophyl Angles	115
Disposable Evacuator tips	116
Lab Products	117
Disposable Prophyl Cups & Brushes	117
X-Ray Film Holders & Utility Tray	119
Film Mounts	120-123
Autoclavable Air / Water Syringe Tips	124
Deluxe Autoclaveable Valves	125
Parts & Components	126-133
Order Form	134
Upholstery Color Chart	136

Customer Care (8:00 a.m. – 5 p.m. PST)
 Customer Service Fax Orders
 Technical Support
 Sales Support
 International Sales
 Latin america sales
 Shipping
 Accounting
 Customer Service
 Ordering

1-626-810-4337
 1-626-810-4245
 service@tpcdental.com
 sbeckley@tpcdental.com
 dwang@tpcdental.com
 charles@tpcdental.com
 holly@tpcdental.com
 vwang@tpcdental.com
 customerservice@tpcdental.com
 customerservice@tpcdental.com



Ordering Information:

When placing orders, please include the following information. All orders will be processed upon receipt of a faxed, mailed, or e-mailed hardcopy of the purchase order.

- Model and/or Part Number
- Requested Ship Date
- Description / Voltage
- Purchase Order Number
- Quantity
- Shipping Instructions
- Cancellations must be confirmed in writing
- All credit

cards are accepted unless otherwise noted

Returned Goods:

All returns require prior authorization. Returns must be authorized by TPC within 7 days of date received by the customer.

- Contact Customer Service for Return Authorization Number
- Returned products are subject to a 25% restocking charge
- All returned goods must have Return Authorization Number
- All returned goods must be shipped prepaid
- All authorized returns must be received by TPC in original packaging, accessories, documentation and in original condition for credit considerations
- All outbound repair / warranty freight charges are the responsibly of the customer.
- **No returns accepted after 14 days.**

Special Orders:

- Special order items and custom made products are not returnable for credit

Repair Estimates:All repair estimates are \$35. If approved for repair, the \$35 will be applied to the repair invoice.

Minimum Orders:

- Orders less than \$50.00 will incur an additional \$5.00 handling charge.
- All drop ship orders will incur an additional \$5.00 fee.

Terms of Sale:

- Claims: All claims for merchandise received that are not in accordance with the original purchase order must be made within five (5) working days of the receipt of the merchandise. All merchandise is quality inspected and packaged in perfect condition. The common carrier assumes full responsibility for the safe delivery of all merchandise after it is removed from the F.O.B. shipping point. All claims for shortages, loss or damage must be documented and filed promptly with the freight carrier. Concealed damage must be reported to the freight carrier immediately upon discovery, with a request for inspection. If a request is made more than 15 days after the receipt of the merchandise, reasonable evidence must be submitted indicating that damage could not have occurred after delivery.
- All pricing in catalog is subject to change. Verify all pricing prior to placing order.

Warranty Information (All stated warranties are intended for USA market ONLY):

All of our products sold are guaranteed to be free from defects in workmanship and materials for one year from date of purchase, unless otherwise stated. TPC will repair or replace any defective part at no charge. TPC will not be responsible for labor charges or shipping charges to / from the TPC facility. This guarantee does not cover normal wear or stains on surface finish. The guarantee does not cover damage resulting from improper installation, misuse or accidents incurred in shipping and handling. All claims against the freight carrier must be initiated at the time the damaged items are received. The claim is the responsibility of the customer. We are improving our products on a continuous basis. We reserve the right to make modifications without the need for prior notification and are not obliged

Products:	Warranty Period:	Products:	Warranty Period:
Patient Chairs	5 year limited	Delivery Units	5 year Limited
Curing & Bleaching Systems	2 years	Seating	1 year
Imaging Products	1 year	Mobile Cabinets	1 year
Scaling Products	1 year	Air-Driven Handpieces	1 year
Air Compressor	5 Year limited	Amalgamator	1 year
		Vaccum Pump	5 year limited

Extended Manufacturer Warranty (selective models):

H6000, H6005, H6025, H7005 Lubrication System 2 year
 LED Curing Lights (All Models) 2 year
 AdvanceCAM Intraoral Camera System(s) 2 year
 LED Operatory Lights 2 year

Limited Manufacturer Warranty (selective models):

6 month Manufacturer Warranty (selective models):
 Fiber optic systems, S333, M333, QS222, QM222, ELCA760, ELS736.

Mirage 2.0

Chair Mounted Operatory System



MP2015-550LED-2.0



TP-2005 Touch Pad



Model DR-1102
Optional



Model AS-1101
Optional



MP2000-550LED-2.0

Packing Dimensions (L x W x H)	Weight
Chair: 44 x 29 x 33	340 lbs.
Cushion: 51 x 24 x 10	35 lbs.
Unit: 39 x 29 x 23	60 lbs.
Assist PKG: 43 x 25 x 12	40 lbs.
Dental Light Arm L600: 34 x 11 x 5	30 lbs.
Dental Light Head L550: 17 x 15 x 7	
Cuspidor 26 x 18 x 10	20 lbs.

Mirage 2.0

Chair Mounted Operatory System

Description	Model	Suggested Retail Price
Mirage 2.0 Operatory Package with Cuspidor	MP2000-550LED-2.0	\$12,020
Mirage 2.0 Operatory Package with Assistant's Instrumentation	MP2015-550LED-2.0	\$11,320
Packages include the following:	(with cuspidor)	(without cuspidor)
4000-2.0 Hydraulic patient chair with wide back and full lumbar support, rotating armrests left or right, double articulating headrest with sliding height adjustment, 30 degree swivel from left and right of center, 3 programmable positions with automatic return and foot control	✓	✓
2015-2.0 Asepsis 3 Handpiece automatic control with coolant controls, flex arm with air brake, diaphragm block design, wet/dry variable speed foot control, deluxe utility center with air /water filters and regulators, master shut off valves. Includes 3 way syringe and light post with cutout for internal wires and monitor bracket Asepsis telescoping 4 position assistant's package, Hve and saliva ejector, water / air quick disconnects, solids collector clean water system	✓	✓
L550-LED Lustrous LED post mounted light with adjustable intensity, 8,000-30,000 Lux	✓	✓
2000-2.0 Porcelain cuspidor with timed bowl rinse and cup filler, telescoping 4 position assistant's package, Hve and saliva ejector, water / air quick disconnects, solids collector and clean water system	✓	
Options: "Options are not factory-installed unless specified on the purchase order. Additional charges apply."		Retail
TPC3WAY-PRT	Additional autoclavable 3 way syringe with tubing	\$78.00
P2335+TB	Deluxe autoclavable Hve Long valve with tubing	\$67.00
WIC800	Standard flat screen monitor bracket	\$118.00
WIC825	Deluxe flat screen monitor bracket with 16" extension Arm	\$390.00
WIC840	Mirage flat screen monitor bracket with 16" extension Arm	\$190.00
MO17	17" LCD multi media flat screen monitor	\$540.00
A800N-1	Advance 800 piezo scaler – built in	\$530.00
H7000	Illumination System – ISO B (5 hole) – tubing, control box, bulb, power supply	\$310.00
H7040	Illumination handpiece tubing – 5 hole	\$120.00
H7070-LED	Fiber optic bulb cartridge	\$58.00
H7660	Illumination System- ISO C (6 pin) – tubing, control box, power supply	\$270.00
H7045	Illumination handpiece tubing- 6 pin	\$120.00
ALED55BN-A	LED 5W curing light – built in to dental unit	\$410.00
TP-2005	Touch pad control – unit head or dental chair mounted 3 preset, auto return, last position	\$358.00
53016-L-100	Disposable Solids Collector Trap, 2 1/8' (pack of 100)	\$45.00
2000-C-2.0	Mirage Cuspidor	\$700.00
TPE-2011	Touch pad Control - Chair & Electric Motor System touch pad	\$460.00
EMB-901	Built in Electric Motor System	\$1,790.00
XV100	Super thin X-ray film viewer	\$140.00
XV150-R	X-ray film viewer bracket (curved) for TPC Mirage unit only	\$80.00
AS-1101	Mirage Assistants stool	\$778.00
DR-1102	Mirage doctor's stool	\$630.00

Mirage 2.0

Chair Mounted Operatory System



MP2015-L600LED-2.0



L600-LED

2015-2.0

TP-2005 Touch Pad

M4000-2.0



Model DR-1102
Optional



Model AS-1101
Optional



MP2000-L600LED-2.0

Packing Dimensions (L x W x H)	Weight
Chair: 44 x 29 x 33	340 lbs.
Cushion: 51 x 24 x 10	35 lbs.
Unit: 39 x 29 x 23	60 lbs.
Assist PKG: 43 x 25 x 12	40 lbs.
Dental Light Arm L600: 34 x 11 x 5	30 lbs.
Dental Light Head L600: 17 x 15 x 7	
Cuspidor 26 x 18 x 10	20 lbs.

Mirage 2.0

Chair Mounted Operatory System

Description	Model	Suggested Retail Price
Mirage 2.0 Operatory Package with Cuspidor	MP2000-600LED-2.0	\$12,220
Mirage 2.0 Operatory Package with Assistant's Instrumentation	MP2015-600LED-2.0	\$11,520
Packages include the following:	(with cuspidor)	(without cuspidor)
4000-2.0 Hydraulic patient chair with wide back and full lumbar support, rotating armrests left or right, double articulating headrest with sliding height adjustment, 30 degree swivel from left and right of center, 3 programmable positions with automatic return and foot control	✓	✓
2015-2.0 Asepsis 3 Handpiece automatic control with coolant controls, flex arm with air brake, diaphragm block design, wet/dry variable speed foot control, deluxe utility center with air /water filters and regulators, master shut off valves. Includes 3 way syringe and light post with cutout for internal wires and monitor bracket Asepsis telescoping 4 position assistant's package, Hve and saliva ejector clean water / air quick disconnects, solids collector with touch pad control	✓	✓
L600-LED Lucent LED post mounted light with adjustable intensity, 3,000-35,000 Lux	✓	✓
2000-2.0 Porcelain cuspidor with timed bowl rinse and cup filler, telescoping 4 position assistant's package, Hve and saliva ejector, water / air quick disconnects, solids collector and clean water system	✓	

Options: "Options are not factory-installed unless specified on the purchase order. Additional charges apply." Retail

TPC3WAY-PRT	Additional autoclavable 3 way syringe with tubing	\$78.00
P2335+TB	Deluxe autoclavable Hve Long valve with tubing	\$67.00
WIC800	Standard flat screen monitor bracket	\$118.00
WIC825	Deluxe flat screen monitor bracket with 16" extension Arm	\$390.00
WIC840	Mirage flat screen monitor bracket with 16" extension Arm	\$190.00
MO17	17" LCD multi media flat screen monitor	\$540.00
A800N-1	Advance 800 piezo scaler – built in	\$530.00
H7000	Illumination System – ISO B (5 hole) – tubing, control box, bulb, power supply	\$310.00
H7040	Illumination handpiece tubing – 5 hole	\$120.00
H7070-LED	Fiber optic bulb cartridge	\$58.00
H7660	Illumination System- ISO C (6 pin) – tubing, control box, power supply	\$270.00
H7045	Illumination handpiece tubing- 6 pin	\$120.00
ALED55BN-A	LED 5W curing light – built in to dental unit	\$410.00
TP-2005	Touch pad control – unit head or dental chair mounted 3 preset, auto return, last position	\$358.00
53016-L-100	Disposable Solids Collector Trap, 2 1/8' (pack of 100)	\$45.00
AS-1101	Mirage Assistants stool	\$778.00
DR-1102	Mirage doctor's stool	\$630.00

Mirage 2.0

Swing Mount Operatory System

#MSP3500-2.0



Model #3550-2.0

Model #3500-2.0

4000-2.0



#L600 LED

Optional: Unit mounted light post LP100 & L600-LED Light Post Mounted LED Light



Optional: TP-2005



Optional: LP100 swing mount light post with optional L600-LED Operatory Light



Optional: Model #L690-LED Ceiling mounted LED operatory light

Packing Dimensions (L x W x H)	Weight
Chair: 44 x 29 x 33	340 lbs.
Cushion: 51 x 24 x 10	35 lbs.
3500: 36 x 28 x 39	100 lbs.
3550: 29 x 12 x 24	25 lbs.
LP100: 45 x 26 x 44	30 lbs.

Mirage 2.0

Swing Mount Operatory System

Description	Model	Suggested Retail Price
Mirage 2.0 Swing Mount Operatory System (without light)	MSP3500-2.0	\$11,330

Packages include the following:

4000-2.0	Hydraulic patient chair with wide back and full lumbar support, rotating armrests left or right, double articulating headrest with sliding height adjustment, 30 degree swivel from left and right of center, 4 programmable positions with automatic return and foot control	✓
3500-2.0	Rotating asepsis 3 Handpiece automatic control with coolant controls, flex arm with air brake, diaphragm block design, wet/dry variable speed foot control, deluxe utility center with air /water filters and regulators, master shut off valves. Includes 3 way syringe and clean water system, with touch pad control	✓
3550-2.0	Rear radius asepsis assistant's arm system, Hve and saliva ejector, water quick disconnect and solids collector	✓

Options: "Options are not factory-installed unless specified on the purchase order. Additional charges apply." Retail

3500-2.0	Mirage swing mount unit with chair bracket (for TPC chair only)	\$3,900.00
3550-2.0	Mirage rear swing mount suction package (for TPC chair only)	\$1,040.00
LP-100	Mirage swing mount light post (ordered w/unit)	\$770.00
LP-105	Mirage swing mount monitor post with monitor mounting bracket (ordered w/unit)	\$960.00
L600-LED	Lucent LED Operatory Light	\$1,430.00
L690-LED	Lucent LED Ceiling Mounted Operatory Light	\$1,990.00
L550-LED	Lustrous LED Operatory Light	\$1,230.00
TPC3WAY-PR T	Additional autoclavable 3 way syringe with tubing	\$78.00
P2335+TB	Deluxe autoclavable Hve Long valve with tubing	\$67.00
WIC800	Standard flat screen monitor bracket	\$118.00
WIC825	Deluxe flat screen monitor bracket with 16" extension	\$390.00
WIC840	Mirage flat screen monitor bracket with 16" extension	\$190.00
MO17	17" LCD multi media flat screen monitor	\$540.00
A800N-1	Advance 800 piezo scaler – built in	\$530.00
H7000	Illumination System – ISO B (5 hole) – tubing, control box, bulb, power supply	\$310.00
H7040	Illumination handpiece tubing – 5 hole	\$120.00
H7070-LED	Fiber optic bulb cartridge	\$58.00
H7660	Illumination System – ISO C (6 pin) – tubing, control box, power supply	\$270.00
H7045	Illumination handpiece tubing – 6 pin	\$120.00
ALED55BN-A	LED 5W curing light – built in to dental unit	\$410.00
TP-2005	Touch pad control – unit head or dental chair mounted 3 preset, auto return, last position, Light on / off, Cuspidor Control	\$358.00
XV100	Super thin X-ray film viewer	\$140.00
XV150-R	X-ray film viewer bracket (curved) for TPC Mirage Unit only	\$80.00
TPCRDSBRKT	TPC Radius Bracket	\$400.00
53016-L	Disposable Solids Collector Trap 2 1/8" (pack of 100)	\$45.00
TPE-2011	Touch pad Control - Chair & Electric Motor System Touch pad	\$460.00
EMB-901	Built in Electric Motor System	\$1,790.00
AS-1101	Mirage Assistants stool	\$778.00
DR-1102	Mirage doctor's stool	\$630.00

Mirage 2.0

Patient Chair



Model #4000-2.0

Foot Control

Hands-free positioning of the patient. 2-programmable positions plus an entry/exit position and last position.



Steel base with high durability plastic cover



Armrests swing-out for patient entry and exit from the chair



Re-enforced seat upholstery provides extra comfort and high durability



Articulating dual axis headrest rotation allows for optimum positioning of the oral cavity without the need to reposition the chair



Locking lever allows user to lock chair into desired position



Seat rotates 30° to left and right of center to accommodate different working styles and to maximize access to intraoral x-ray system



Safety shut-off plate disables seat down/backrest recline functions to prevent injury to the operator or damage to items beneath the plate.

Specifications:

Lifting/lowering mechanism:	Hydraulic, cantilever type
Initial height/stroke:	15.5" / 15"
Backrest reclining angle:	0° (Horizontal) – 70°
Seat tilting:	10° – 20°, synchronized with backrest
Preset position:	Microcomputer control. Three preset position, autoreturn, last position
Chair rotation angle:	30° left / 30° right of centerline
Headrest:	Dual axis type
Safety shut-off plate:	Under the main link
Emergency stop:	Any switch can cancel chair movement
Warranty	5 Year Limited

Standard Features:

- Synchronous backrest
- Articulating dual axis headrest
- Steel plate base
- Swing-away armrests
- Programmable foot control
- Long pump cover

Mirage 2.0

Patient Chair

Description

Mirage 2.0 Hydraulic Patient Chair

Product includes the following:

- Two programmable positions
- One preset exit position
- Electronic foot control with auto return function
- Built-in fuse / surge protection
- Toe guard protection to prevent scuffing
- All-metal construction
- Safety shut-off base plate
- Double articulating headrest, adjustable for height and wheelchair positioning
- Locking swivel, 60 degree
- Pivoting armrests for easy entry to and exit from chair
- Seamless Upholstery
- Wide chair back
- Coordinated leg rest tilt
- Input voltage 110V or 220V

Model

#4000-2.0

Suggested Retail Price

\$6,390

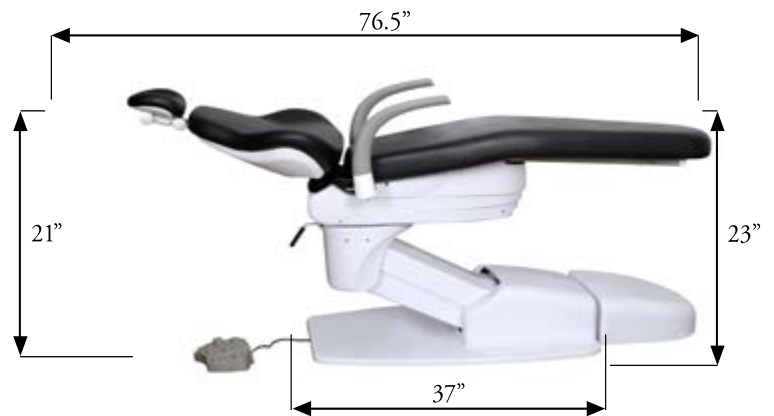

Standard: PC-1000-DU
Wide backrest



Optional: TP-2005 Touch pad control installed on dental chair

Packing Dimensions (L x W x H)	Weight
Chair: 44 x 29 x 34	340 lbs.
Cushion: 51 x 24 x 10	35 lbs.
Chair Bracket 11 x 5 x 25	35 lbs.

Options: "Options are not factory-installed unless specified on the purchase order. Additional charges apply."

Retail

TP-2005	Touch pad control – unit head or dental chair mounted, 3 preset, auto return, last position	\$358.00
TPCBRKT	TPC post mount chair bracket	\$290.00
PC-1000-DU	Replacement Dental Chair Upholstery Duration Vinyl -Wide Back	\$850.00
PC-1000-Vinyl-UC	Upcharge Non-Standard Dental Chair Upholstery Vinyl -Wide Back	\$490.00
PC-1000-ULTR-UC	Upcharge Ultra leather Dental Chair Upholstery leather -Wide Back	\$760.00
PC-1000-PR-UC	Upcharge Nauga Soft Dental Chair Upholstery Vinyl -Wide Back (PR50, 49, 47, 40, 37)	\$300.00

* Specify color and product code when ordering *

Mirage 2.0

Orthodontic Hydraulic Patient Chair



Model #3000-2.0

Foot Control

Hands-free positioning of the patient. 2-programmable positions plus an entry/exit position and last position.



Steel base with high durability plastic cover



Armrests swing-out for patient entry and exit from the chair



Re-enforced seat upholstery provides extra comfort and high durability



Articulating dual axis headrest rotation allows for optimum positioning of the oral cavity without the need to reposition the chair



Locking lever allows user to lock chair into desired position



Seat rotates 30° to left and right of center to accommodate different working styles and to maximize access to intraoral x-ray system



Safety shut-off plate disables seat down/backrest recline functions to prevent injury to the operator or damage to items beneath the plate.

Specifications:

Lifting/lowering mechanism:	Hydraulic, cantilever type
Initial height/stroke:	15.5" / 15"
Backrest reclining angle:	0° (Horizontal) – 70°
Seat tilting:	10° – 20°, synchronized with backrest
Preset position:	Microcomputer control. Three preset position, autoreturn, last position
Chair rotation angle:	30° left / 30° right of centerline
Headrest:	Dual axis type
Safety shut-off plate:	Under the main link
Emergency stop:	Any switch can cancel chair movement
Warranty	5 Year Limited

Standard Features:

- Synchronous backrest
- Articulating dual axis headrest
- Cast aluminum base
- Programmable foot control
- Short pump cover

Mirage 2.0

Orthodontic Hydraulic Patient Chair

Description

Mirage 2.0 Orthodontic Hydraulic Patient Chair

Model

#3000-2.0

Suggested Retail Price

\$6,190

Packages include the following:

- Two programmable positions
- One preset exit position
- Electronic foot control with auto return function
- Built-in fuse / surge protection
- Toe guard protection to prevent scuffing
- All-metal construction
- Safety shut-off base plate
- Double articulating headrest, adjustable for height and wheelchair positioning
- Locking swivel, 60 degree
- Seamless Upholstery
- Coordinated leg rest tilt
- Input voltage 110V or 220V



Optional: TP-2005 Touchpad control installed on dental chair



Options: "Options are not factory-installed unless specified on the purchase order. Additional charges apply."

Retail

Options	Description	Retail
TP-2005	Touch pad control – unit head or dental chair mounted, 3 preset, auto return, last position	\$ 358.00
TPCBRKT	TPC Post mount chair bracket	\$ 290.00
PC-1000-DU	Replacement Dental Chair Upholstery-Wide Back Duration Vinyl- Specify Color and Product Code	\$850.00
PC-1000-Vinyl-UC	Upcharge Non-Standard Dental Chair Upholstery-Wide Back Vinyl- Specify Color and Product Code	\$490.00
PC-1000-ULTR-UC	Upcharge Ultra leather Dental Chair Upholstery-Wide Back Ultra leather- Specify Color and Product Code	\$760.00
PC-1000-PR-UC	Upcharge Nauga Soft Dental Chair Upholstery-Wide Back Nauga Soft- Specify Color and Product Code (PR50, 49, 47, 40, 37)	\$300.00
M4000-09	Magnetic Pillow Headrest	\$420.00

Packing Dimensions (L x W x H)	Weight
Chair: 44 x 29 x 33	340 lbs.
Cushion: 51 x 24 x 10	35 lbs.

Mirage 2.0

Orthodontic Package

Standard Features:

- Synchronous backrest
- Articulating dual axis headrest
- Laser Cut Steel
- Programmable foot control
- Long pump cover
- Hydraulic pump for quiet operation

Standard Features:

- Integrated non cure mode
- 24V DC power Supply
- Bulb type: 4 White LEDs 2 Yellow
- Light intensity (Lux):
High 30,000;
Low 8,000
- Focal length: 27" (70 cm)
- Illumination area: 100mm x180mm
- Sensor mode only

Standard Control Features:

- 3 HP Automatic selection
- 3-way Syringe
- Vacuum package with saliva ejector and hve
- Self contained water bottle system
- Variable speed disc-type foot control
- Water coolant on/off switch with flow control
- 1 Year warranty
- Requires central air and vacuum for plumbing



Optional:
OMC-2200
LCD Bracket

Optional: Magnetic
headrest

Counter top
dimensions

Rear cabinet
door view

Pull out writing
surface

Packing Dimensions (L x W x H)	Weight
Chair: 44 x 29 x 33	340 lbs.
Cushion: 51 x 24 x 10	35 lbs.
Light Arm L600 26 x 14 x 8	30 lbs.
Light Head L550 17 x 15 x 7	
Cabinet 32 x 28 x 41	140 lbs.

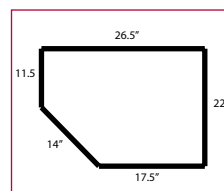



Mirage 2.0

Orthodontic Package

Description	Model	Suggested Retail Price
Mirage 2.0 Orthodontic Package	MOP3000-550LED-2.0	\$10,290

Packages include the following:

3000-2.0 Hydraulic patient chair with wide back and full lumbar support, double articulating headrest with sliding height adjustment, 30 degree swivel from left and right of center, 4 programmable positions with automatic return and foot control ✓

OMC2375 This orthodontic mobile delivery cabinet offers a pullout writing surface, two instrument drawers, one medium and two large storage drawers for materials and supplies that fully extend and quickly remove for easy cleaning. In addition, these cabinets provide a large open space for accessories with convenient access from the front. Oversized locking dual-caster wheel ✓

L550-LED Lustrous LED operatory light with Poliblock mode 8,000 - 30,000 LUX , dual axis light head rotation ✓

TPCBRKT The chair bracket is included at no charge (value: \$290) when purchasing the Mirage Orthodontic Package ✓

Options: "Options are not factory-installed unless specified on the purchase order. Additional charges apply."

		Retail
WIC840	Mirage flat screen monitor bracket with 16" extension	\$190.00
MO17	17" LCD multi media flat screen monitor	\$540.00
H7000	Illumination System – ISO B (5 hole) – tubing, control box, bulb, power supply	\$310.00
H7660	Illumination System – ISO C (6 pin) – tubing, control box, power supply	\$270.00
ALED55BN-A	LED 5W curing light – built in to dental unit	\$410.00
TP-2005	Touch pad control – dental chair mounted 3 preset, auto return, last position	\$358.00
OMC2200	LCD monitor bracket	\$300.00
53016-L-100	Disposable Solids Collector Trap 2 1/8" (Pack of 100)	\$45.00
OMC-ST81	Optional Stone Surface on OMC 2375, Color Artic	\$380.00
OMC-ST82	Optional Stone Surface on OMC 2375, Color White	\$380.00
OMC-ST85	Optional Stone Surface on OMC 2375, Color Cream	\$380.00
OMC-ST86	Optional Stone Surface on OMC 2375, Color Bamboo	\$380.00
M4000-09	Optional Magnetic Headrest	\$420.00
AS-1101	Mirage Assistants stool	\$778.00
DR-1102	Mirage doctor's stool	\$630.00

Optional: Stone Counter top
OMC-ST81

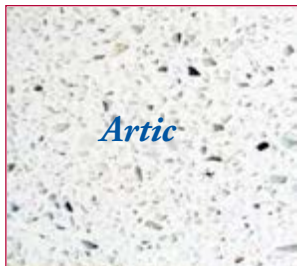

Artic

Optional: Stone Counter top
OMC-ST82



White

Optional: Stone Counter top
OMC-ST85



Cream

Optional: Stone Counter top
OMC-ST86



Bamboo

Laguna 2.0

Electromechanical Patient Chair



Model#L2000-2.0

Foot Control
Hands-free positioning of the patient.
2-programmable positions plus an entry/exit position.



Wide backrest provides extra comfort and durability



Articulating dual axis headrest rotation allows for optimum positioning of the oral cavity without the need to reposition the chair



Armrests pivot in and out for patient entry and exit from the chair



Solid steel base

Specifications:

Lifting/lowering mechanism:	Electromechanical, cantilever type
Initial height/stroke:	15.5" / 15"
Backrest reclining angle:	0° (Horizontal) – 70°
Seat tilting:	10° – 20°, synchronized with backrest
Preset position:	Microcomputer control. Three preset position, auto return, last position
Chair rotation angle:	Fixed
Headrest:	Dual axis type
Safety shut-off plate:	Under the main link
Emergency stop:	Any switch can cancel chair movement
Warranty	5 Year Limited

Standard Features:

- Independent backrest
- Articulating dual axis headrest
- Solid steel base
- Programmable foot control



Laguna 2.0

Electromechanical Patient Chair

Description	Model	Suggested Retail Price
Laguna 2.0 Electromechanical Patient Chair	#L2000-2.0	\$4,100

Packages include the following:

- Two programmable positions
- One preset exit position
- Electronic foot control with auto return function
- Built-in fuse / surge protection
- Toe guard protection to prevent scuffing
- All-metal construction
- Double articulating headrest, adjustable for height and wheelchair positioning
- Seamless Upholstery
- Input voltage 110V or 220V



Optional: TP-2005 Touch pad control installed on dental chair



Model#L2000-2.0

Packing Dimensions (L x W x H)	Weight
Chair: 44 x 29 x 33	340 lbs.
Cushion: 51 x 24 x 10	35 lbs.

Options: "Options are not factory-installed unless specified on the purchase order. Additional charges apply."

		Retail
TP-2005	Touch pad control – Unit mounted, 3 preset, auto return, last position	\$ 358.00
PC-5000-DU	Upcharge Dental Chair Upholstery-Wide Back Duration Vinyl- Specify Color and Product Code	\$790.00
PC-5000-Vinyl-UC	Upcharge Non-Standard Dental Chair Upholstery-Wide Back Vinyl- Specify Color and Product Code	\$490.00
PC-5000-ULTR-UC	Upcharge Ultra leather Dental Chair Upholstery-Wide Back Ultra leather- Specify Color and Product Code	\$760.00
LAGBRKT	Laguna Post mount chair bracket	\$ 290.00

Laguna 2.0

Chair Mounted Operatory System



LP2100-550LED-2.0



Optional
MO17 LCD Monitor

#L550-LED

2000-2.0

TP-2005

#L2000-2.0

Packing Dimensions (L x W x H)	Weight
Chair: 44 x 29 x 33	340 lbs.
Cushion: 51 x 24 x 10	35 lbs.
Unit: 39 x 29 x 23	60 lbs.
Unit: 43 x 25 x 12	40 lbs.
Dental Light: 34 x 11 x 5	30 lbs.
Light Head: 12 x 15 x 7	
Cuspidor 20 x 13 x 14	20 lbs.

Laguna 2.0

Chair Mounted Operatory System

Description	Model	Suggested Retail Price
Laguna 2.0 Operatory Package with Cuspidor	LP2100-550LED-2.0	\$9,730
Laguna 2.0 Operatory Package with Assistant's Instrumentation	LP2115-550LED-2.0	\$9,030
Packages include the following:	(with cuspidor)	(without cuspidor)
L2000-2.0 Electromechanical patient chair with wide back and full lumbar support, rotating armrests left or right, double articulating headrest with sliding height adjustment, 3 programmable positions with automatic return and foot control	✓	✓
2015-2.0 Asepsis 3 Handpiece automatic control with coolant controls, flex arm with air brake, diaphragm block design, wet/dry variable speed foot control, deluxe utility center with air /water filters and regulators, master shut off valves. Includes 3 way syringe and light post with cutout for internal wires and monitor bracket Asepsis rotating 4 position assistant's package, Hve and saliva ejector, water disconnect solids collector and clean water system. With Touch pad control.	✓	✓
L550-LED Lustrous LED post mounted light with adjustable intensity, 8,000-30,000 Lux	✓	✓
2000-2.0 Porcelain cuspidor with timed bowl rinse and cup filler, rotating 4 position assistant's package, Hve and saliva ejector, water quick disconnect, solids collector and clean water system With Touch pad control.	✓	

Options: "Options are not factory-installed unless specified on the purchase order. Additional charges apply." Retail

TPC3WAY-PRT	Additional autoclavable 3 way syringe with tubing	\$78.00
P2335+TB	Deluxe autoclavable Hve Long valve with tubing	\$67.00
WIC800	Standard flat screen monitor bracket	\$118.00
WIC825	Deluxe flat screen monitor bracket with 16" extension	\$390.00
WIC840	Mirage flat screen monitor bracket with 16" extension	\$190.00
MO17	17" LCD multi media flat screen monitor	\$540.00
A800N-1	Advance 800 piezo scaler – built in	\$530.00
H7000	Illumination System – ISO B (5 hole) – tubing, control box, bulb, power supply	\$310.00
H7040	Illumination handpiece tubing – 5 hole	\$120.00
H7070-LED	Fiber optic bulb cartridge	\$58.00
H7660	Illumination System- ISO C (6 pin) – tubing, control box, power supply	\$270.00
H7045	Illumination handpiece tubing- 6 pin	\$120.00
ALED55BN-A	LED 5W curing light – built in to dental unit	\$410.00
TP-2005	Touch pad control – unit head or dental chair mounted 3 preset, auto return, last position	\$358.00
53016-L-100	Disposable Solids Collector Trap, 2 1/8' (pack of 100)	\$45.00
2000-C-2.0	Mirage Cuspidor with touch pad control	\$700.00
TPE-2011	Touch pad Control - Chair & Electric Motor System touch pad	\$460.00
EMB-901	Built in Electric Motor System	\$1,790.00
XV100	Super thin X-ray film viewer	\$140.00
XV150-R	X-ray film viewer bracket (curved) for TPC Mirage unit only	\$80.00
AS-1101	Mirage Assistants stool	\$778.00
DR-1102	Mirage doctor's stool	\$630.00

Laguna 2.0

Orthodontic Package



Standard Features:

- Independent backrest
- Articulating dual axis headrest
- Steel base
- Armrests rotate in and out
- Programmable foot control
- Short pump cover
- Electric motor operated

Standard Features:

- Intergrated non cure mode
- 24V DC power Supply
- Bulb type: 4 White LEDs 2 Yellow
- Light intensity (Lux):
High 30,000;
Low 8,000
- Focal length: 27" (70 cm)
- Illumination area: 100mm x180mm
- Sensor mode only

Standard Control Features:

- 3 HP Automatic selection
- 3-way Syringe
- Vacuum package with saliva ejector and hve
- Self contained water bottle system
- wet / dry foot control
- 1 Year warranty
- Requires central Air / vacuum systems
- Includes utility center and junction box

LOP2000-L550LED-2.0



OMC2375

Optional OMC 2200
Monitor Bracket



Pull out writing
surface

Standard Cabinet Features:

- Five easy to remove and clean full extension drawers, and one pull-out writing surface.
- High quality hardware throughout
- Oversized caster wheels with locks
- A removable counter - top plastic tray
- Standard 12" X 12" Junction Box
- 7' Length of umbilical

Rear cabinet
door view

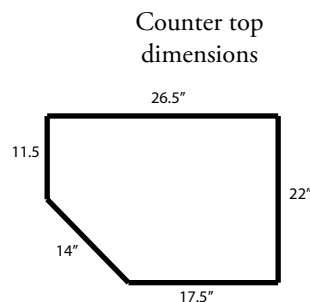

Packing Dimensions (L x W x H)	Weight
Chair: 44 x 29 x 33	340 lbs.
Cushion: 52 x 24 x 10	35 lbs.
Light Arm: L600 26 x 14 x 8	30 lbs.
Light Head: L550 17 x 15 x 7	
Cabinet 32 x 28 x 41	140 lbs.



Laguna 2.0

Orthodontic Package

Description	Model	Suggested Retail Price
Laguna 2.0 Orthodontic Package	LOP2000-L550LED-2.0	\$8,200

Packages include the following:

L2000-2.0 Electromechanical patient chair with wide back and full lumbar support, double articulating headrest with sliding height adjustment, 3 programmable positions with automatic return and foot control ✓

OMC-2375 This orthodontic mobile delivery cabinet offers a pullout writing surface, two instrument drawers, one medium and two large storage drawers for materials and supplies that fully extend and quickly remove for easy cleaning. In addition, these cabinets provide a large open space for accessories with convenient access from the front. Oversized locking dual-casters. ✓

L550-LED Lustrous LED post mounted light with dual intensity, 8,000 - 30,000 LUX, dual axis light head rotation ✓

LAGBRKT The chair bracket is included at no charge (value: \$290) when purchasing the Laguna Orthodontic Package ✓

Options: "Options are not factory-installed unless specified on the purchase order. Additional charges apply."

Retail

WIC840	Mirage flat screen monitor bracket with 16" extension	\$190.00
MO17	17" LCD multi media flat screen monitor	\$540.00
H7000	Illumination System – ISO B (5 hole) – tubing, control box, bulb, power supply	\$310.00
H7660	Illumination System – ISO C (6 pin) – tubing, control box, power supply	\$270.00
ALED55BN-A	LED 5W curing light – built in to dental unit	\$410.00
TP-2005	Touch pad control – dental chair mounted 3 preset, auto return, last position	\$358.00
OMC2200	LCD monitor bracket	\$300.00
53016-L-100	Disposable Solids Collector Trap 2 1/8" (Pack of 100)	\$45.00
OMC-ST81	Optional Stone Surface on OMC 2375, Color Artic	\$380.00
OMC-ST82	Optional Stone Surface on OMC 2375, Color White	\$380.00
OMC-ST85	Optional Stone Surface on OMC 2375, Color Cream	\$380.00
OMC-ST86	Optional Stone Surface on OMC 2375, Color Bamboo	\$380.00
LAGBRKT	Laguna Post mount chair bracket	\$290.00
AS-1101	Mirage Assistants stool	\$778.00
DR-1102	Mirage doctor's stool	\$630.00

Optional: Stone Counter top
OMC-ST81

Optional: Stone Counter top
OMC-ST82

Optional: Stone Counter top
OMC-ST85

Optional: Stone Counter top
OMC-ST86



Mirage 2.0

Chair Mounted Delivery System



Standard Features

- Asepsis automatic control for three handpieces
- Individual handpiece pressure adjustments
- Non-retracting water coolant with on/off
- Individual water coolant flow controls
- Air coolant flow control
- Handpiece tubing flush system
- Ultra soft handpiece tubing
- 6-pin straight gray asepsis tubing with Midwest connector. (5-Hole tubing optional)
- Disc foot control wet/dry toggle with 7' of smooth tubing
- Equipment utility center with asepsis housing
- Vacuum canister with solids collector screen
- Water quick disconnect
- Self contained water system with city/bottle selector switch
- Straight light post for unit mount dental light
- Pre-wiring for fiber optic light source
- Air-actuated counterbalanced arm lock
- 3 way syringe on unit head
- Touch pad control

Model #2000-2.0

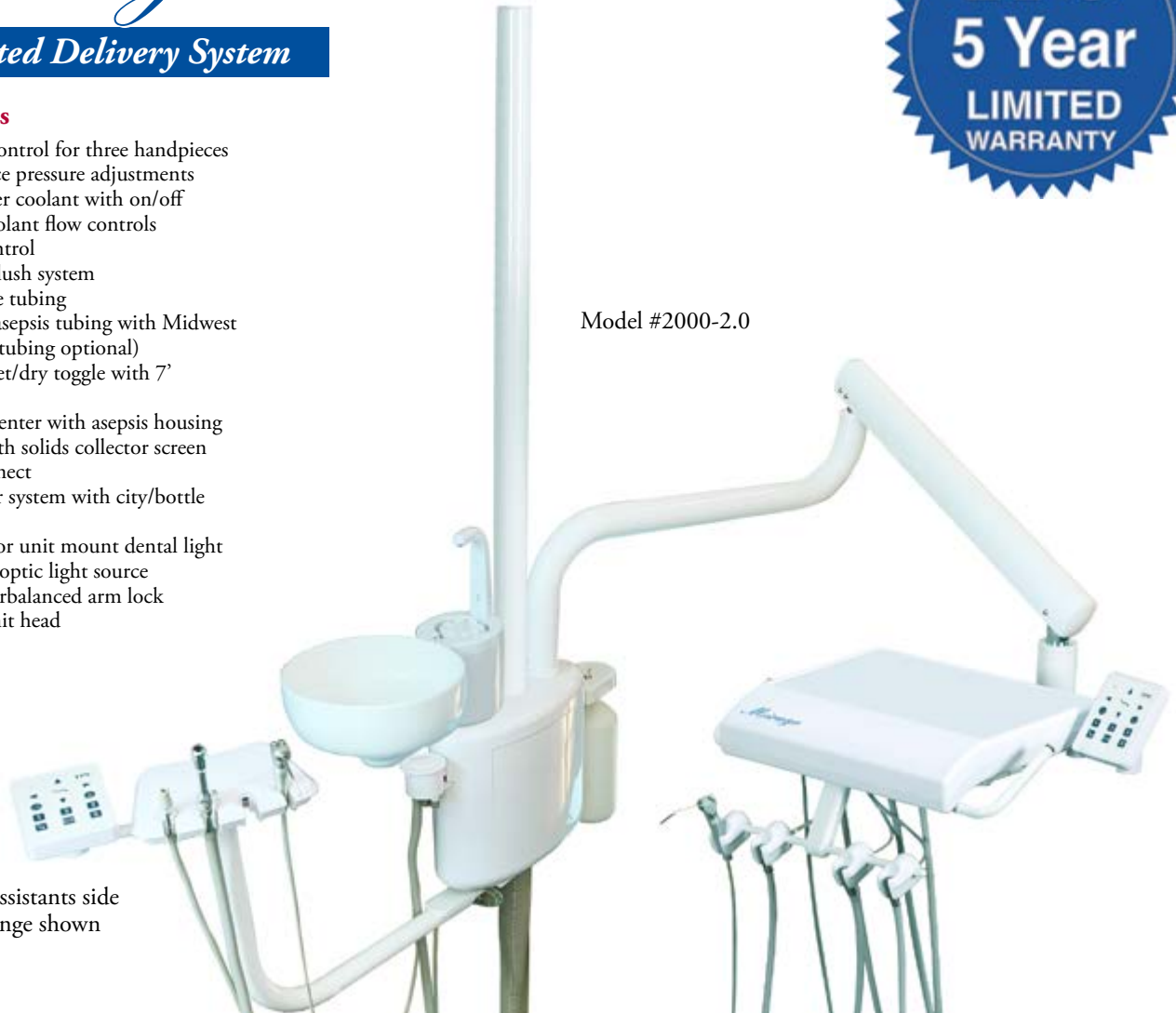

Optional: Assistants side 3-way syringe shown

Gravity Drain Cuspidor

- Contoured bowl is made of fine porcelain for easy cleaning and infection control.
- The cuspidor operates with a timed bowl rinse and cup filler
- Swing away cuspidor bowl
- Electric solenoid water flow controlled
- Touch pad control



Control Head: Easy access controls for simple adjustments. Ultra soft handpiece tubing minimizing hand and wrist stress.



Cuspidor Bowl: The deep contoured bowl is made of fine porcelain for easy cleaning and infection control.



Optional: Multi media flat screen monitor for chair side intraoral imaging, patient education and DVD viewing.

Assistant's Instrumentation on Rotating Arm

- 1 autoclavable HVE with asepsis tubing
- 1 autoclavable saliva ejector with asepsis tubing
- Optional Assistants side 3-way syringe



Built in self contained 1500ml water bottle system including city/bottle selector switch.



Optional: Assistants side 3-way syringe



Built in water quick disconnect for ultrasonic scaling.

Options

- Built In Electric Handpiece
- Built-in Led curing light
- Built-in scaler
- Illumination light source
- Post-mounted utility tray
- 17" LCD Monitor
- LCD monitor bracket



Mirage 2.0

Chair Mounted Delivery System

Model #2015-2.0

Optional: Assistants side
3-way syringe shown



Optional: TP-2005
Touchpad control



Optional: TPE-2011
Touchpad control

Packing Dimensions (L x W x H)	Weight
Unit: 39 x 29 x 23	60 lbs.
Unit PMU: 43 x 25 x 12	40 lbs.
Cuspidor: 26 x 18 x 10	20 lbs.

Description

Mirage 2.0 Chair Mounted Delivery System with Cuspidor
Mirage 2.0 Chair Mounted Delivery System

Model

2000-2.0

Suggested Retail Price

2015-2.0

\$4,400

\$3,700

Package includes the following:

(with cuspidor)

(without cuspidor)

Asepsis 3 handpiece automatic control with coolant controls, flex arm with dual air brake, tri block design, wet/dry variable speed foot control, deluxe utility center with air /water filters and regulators, master shut off valves. Includes 3 way syringe and light post with cutout for internal wires and monitor bracket, 7' umbilical with touch pad control



Porcelain cuspidor with sensor controlled bowl rinse and cup filler, rotating 4 position assistant's package, Hve and saliva ejector, water quick disconnect, solids collector and clean water system with touch pad control



Rotating 4 position assistant's package, Hve and saliva ejector, water quick disconnect, solids collector and clean water system, light Post



Options: "Options are not factory-installed unless specified on the purchase order. Additional charges apply."

Retail

TPC3WAY-PRT	Additional autoclavable 3 way syringe with tubing	\$78.00
P2335+TB	Deluxe autoclavable Hve valve with tubing	\$67.00
WIC800	Standard flat screen monitor bracket	\$118.00
WIC825	Deluxe flat screen monitor bracket with 16" extension	\$390.00
WIC840	Mirage flat screen monitor bracket with 16" extension	\$190.00
#MO17	17" LCD multi media flat screen monitor	\$540.00
A800N-1	Advance 800 piezo scaler – built in	\$530.00
H7000	Illumination System – ISO B (5 hole) – tubing, control box, bulb, power supply	\$310.00
H7660	Illumination System – ISO C (6 pin) – tubing, control box, power supply	\$270.00
ALED55BN-A	LED 5W curing light – built in	\$410.00
L600-LED	Lucent LED Operatory Light	\$1,430.00
L550-LED	Lustrous LED Operatory Light "with motion sensor, with manual toggle"	\$1,230.00
BELBRKT	Belmont chair mount bracket (Bel 20/Bel 50)	\$198.00
TPCBRKT	TPC chair mount bracket	\$290.00
TP-2005	Touch pad control – unit head or dental chair mounted, 3 preset, auto return, last position	\$358.00
TPE-2011	Touch pad Control - Chari & Electric Motor System touch pad	\$460.00
53016 -L-100	Disposable Solids Collector Trap, 2 1/8" (pack of 100)	\$45.00
2000-C-2.0	Mirage Cuspidor	\$700.00
EMB-901	Built In Electric Motor system	\$1,790.00
XV100	Super Thin X-ray Viewer	\$140.00
XV150-R	Xray viewer bracket (round cut-out) – mount to Mirage unit head (Round Arm)	\$80.00

Mirage 2.0

Mirage 2.0 Mobile Doctors Cart



Model #MC-501-2.0

Model #MC-500-2.0

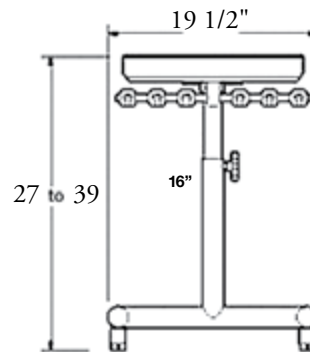

Description

Model

Suggested Retail Price

Mirage 2.0 Mobile Doctors Cart	MC-500-2.0	\$2,200
Mirage 2.0 Mobile Doctors Cart with Vacuum Package	MC-501-2.0	\$2,500
Asepsis 3 handpiece automatic selection with bottle system	✓	✓
3 way syringe with quick change autoclavable tip	✓	✓
Master on/off toggle	✓	✓
Air / Water pressure adjustment for each handpiece	✓	✓
Pressure gauge	✓	✓
Non-retracting water / air coolant adjustment and purge	✓	✓
Asepsis handpiece tubing	✓	✓
Painted H-frame with height adjustment, 27" to 39"	✓	✓
Vacuum canister with removable screen 2 1/8"		✓
1 autoclavable Hve and saliva ejector and tubing		✓
Variable speed foot control	✓	✓
10 feet of umbilical	✓	✓

Options: "Options are not factory-installed unless specified on the purchase order. Additional charges apply."

Retail

H7000	Illumination System – ISO B (5 hole) – tubing, control box, bulb, power supply	\$310.00
H7660	Illumination System – ISO C (6 pin) – tubing, control box, power supply	\$270.00
A800N-1	Advance 800 N piezo scaler – built in	\$530.00
53016-L-100	Disposable Solids Collector Trap, 2 1/8" Pk of 100	\$45.00
MC500-UMB-FT	Additional Umbilical Per Foot	\$20.00
MC501-UMB-FT	Additional Umbilical Per Foot	\$24.00

Model #MC-501-2.0

Model #MC-500-2.0

Packing Dimensions: 29" x 23" x 21" / 50 lbs

Packing Dimensions: 29" x 23" x 21" / 50 lbs



OMC 2375

Orthodontic Mobile Delivery Cabinet



Optional OMC 2200
Monitor Bracket



OMC2375



Artic

OMC-ST81



White

OMC-ST82



Cream

OMC-ST85



Bamboo

OMC-ST86

Optional hard surface stone top



Rear compartment
4" W X 12"D X 20" H

Function:

This orthodontic mobile delivery cabinet offers a pullout breadboard, two instrument drawers, one medium and two large storage drawers for materials and supplies that fully extend and quickly remove for easy cleaning. In addition, these cabinets provide a large open space for accessories with convenient access from the front. The oversized dual-caster wheels, makes positioning of the cabinet simple and easy on all floor surfaces, including carpet.

Standard Cabinet Features:

- Five easy to remove and clean full extension drawers, and one pull-out writing surface.
- High quality hardware throughout
- Oversized caster wheels with LOCKS
- Four stationary handles for easy cart positioning
- A removable counter - top plastic tray
- Standard 12" X 12" Junction Box
- 7' Length of umbilical

Standard Control Features:

- 3 HP Automatic selection
- 3-way syringe
- Vacuum Package with Saliva Ejector and HVE
- Self contained water bottle system
- Variable speed disc-type foot control
- Water coolant on/off switch with flow control
- 1 Year warranty
- Includes Utility center + junction box
- Requires central air and vacuum connections

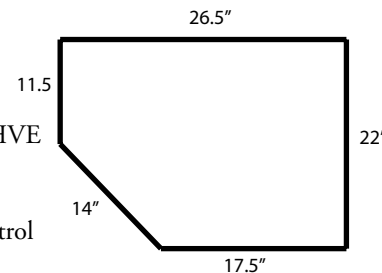

Description

Orthodontic Mobile Delivery Cabinet

Model

OMC2375

Suggested Retail Price

\$2,690

Options: "Options are not factory-installed unless specified on the purchase order. Additional charges apply."

Options	Retail
A800N-1 Advance 800N Piezo Scaler - Built in	\$530.00
ALED55BN-A LED 55BN 5W LED Curing Light -Built in	\$410.00
2375-UMB-FT Umbilical Per Foot	\$31.50
OMC2200 LCD Monitor Bracket W/ Post	\$300.00
OMC-ST81 Optional Stone Surface on OMC 2375, Color Artic	\$380.00
OMC-ST82 Optional Stone Surface on OMC 2375, Color White	\$380.00
OMC-ST85 Optional Stone Surface on OMC 2375, Color Cream	\$380.00

Packing Dimensions: 41" x 28" x 32" / 140 lbs

Superb Air

Oil-less Air Compressor

The TPC Superb Air Oil-less Air Compressors meet the high standards of the dental professionals, providing the reliability you need from a brand you can trust. The new motor design delivers a reduced noise with a 5-year warranty. The membrane air drying system efficiently filters out compressed air contaminants and moisture from the compressed air. Purge tank removes residual humidity in the compressor following each cycle.



DC8124

Model	DC8112	DC8122	DC8124	DC8224	DC8226	DC8228
User Capacity	2 users	2 users	3 users	4 users	5 users	7 users
CDFM @ 80psi	4.9	4.9	9.8	9.8	14.7	19.6
# of Heads	1	1	1	2	2	2
Total HP	1	1	2	2	3	4
Voltage	110V	230V	230V	230V	230V	230V
Line Frequency	60Hz	60Hz	60Hz	60Hz	60Hz	60Hz
Amps	14	14	15	15	22	30
Breaker Amps	20	20	20	20	30	40
dBA	72	72	72	73	73	73
Tank Capacity	10 Gallon	10 Gallon	10 Gallon	16 Gallon	23 Gallon	23 Gallon
Size (HxWxD)	29x28x23	29x28x23	29x28x23	9x28x23	31x34x26	31x34x26



DC8228



Features:

- New motor design to reduce noise and increase reliability
- Quiet operation
- Membrane air drying system to remove moisture from compressed air
- Dry air prevents bacteria growth and air if filtered to 0.01 micron keeping 99.9997% of air contaminants out of your air system
- Energy efficient thermally protected motors
- Superb Air Oil-less compressors are available in single or twin heads
- 5-year warranty

Description	Model	Suggested Retail Price
Superb Air Compressor, 1 HP, 110V	DC8112	\$5,950.00
Superb Air Compressor, 1 HP, 220V	DC8122	\$5,950.00
Superb Air Compressor, 1 x 2 HP, 220V	DC8124	\$6,590.00
Superb Air Compressor, 1 x 1 HP + 1 x 1 HP, 220V	DC8224	\$7,990.00
Superb Air Compressor, 1 x 1 HP + 1 x 2 HP, 220V	DC8226	\$9,590.00
Superb Air Compressor, 2 x 2 HP, 220V	DC8228	\$11,590.00
Options	Model	Suggested Retail Price
Control Panel 3 button Vac, Air, Water	SVCP-3	\$390.00
Control Panel 4 button Vac, Vac, Air, Water	SVCP-4	\$460.00
Air Compressor and Vacuum pump stacking rack	STACK	\$780.00

Shipping Dimensions: L X W X H

- DC8112: 25" X 26" X 35"
- DC8122: 25" X 26" X 35"
- DC8124: 30" X 29" X 37"
- DC8224: 30" X 29" X 37"
- DC8226: 39" X 29" X 37"
- DC8228: 39" X 29" X 37"

SuperbAIR air compressors not to be used for CAD / 3D printers





Superb Vac

Wet-Ring Vacuum



Model	WV3 (Single)	WV5 (Single)	WV6(Twin)	WV10 (Twin)
Water consumption without water recycling:	4L/min	4L/min	6L/min	6L/min
Water consumption with TPC water recycling:	.8L/min	.8L/min	1.0L/min	1.0L/min
Suction Rate	900L/min	1500L/min	1800L/min	3000L/min
Vacuum Level (1N Hg) Factory set to 10HG	8-15 HG	8-15 HG	8-15 HG	8-15 HG
Noise Level dB (A)	58	58	65	65
Horse Power	1.2 HP	2 HP	2.4 HP	4 HP
Voltage	110V or 220V	220V	220V	220V
Frequency	50/60Hz	50/60Hz	50/60Hz	50/60Hz
Max. users	3	5	6	10
Current (A)	8A	13A	8Ax2	13Ax2
Circuit Breaker (A)	20A	20A	20Ax2	20Ax2
Inlet Connection Size	3/4"	3/4"	1"	1"
Drain Connection Size	1.25"	1.25"	1.25"	1.25"
City Water Connection Size	3/8"	3/8"	3/8"	3/8"
Air Exhaust Connection Size	2 3/8"	2 3/8"	2 3/8"	2 3/8"
Inlet Water Pressure (PSI)	10Psi / 0.7bar	10Psi / 0.7bar	10Psi / 0.7bar	10Psi / 0.7bar
Ambient Temperature	2 C- 40	2 C- 40	2 C- 40	2 C- 40
Product Size (LxWxH) Inches	16.5x14x18	16.5x14x18	28x17x18	28x17x18
Product Weight (LBS)	62lbs	66lbs	176lbs	198lbs

Features:

- Durable aluminum-bronze construction
- Stainless steel impeller
- Computer balanced, sealed bearings in motor
- Large capacity, easy to clean filter with clear bowl for easy inspection
- Available in single and twin models to accommodate 1-10 users
- 5-year full product limited warranty
- Unique water recycling to save up to 80% water
- UL/CUL classified
- 110V or 220V 50/60 Hz
- 2 3/8" air exhaust connection size
- 20Amp circuit breaker
- Noise level less than < 58 dB
- 3/8" city water connection
- 3/4" inlet connection
- Stainless steel impeller
- NFPA 99C level 3-compliant

Description	Model	Suggested Retail Price
Superb Vac(3) 1.2 HP	WV3(Single)	\$2,590.00
Superb Vac(3R) 1.2 HP (with recycler)	WV3R(Single)	\$2,900.00
Superb Vac(5) 2HP	WV5(Single)	\$2,990.00
Superb Vac(5R) 2HP (with recycler)	WV5R(Single)	\$3,300.00

Product includes the following:

3 Simultaneous users	✓	✓	✓	✓
5 Simultaneous users			✓	✓
Water recycler		✓		✓
220V 50/60Hz		✓	✓	✓
Adjustable vacuum level from 8-15Hg	✓	✓	✓	✓

Options	Model	Suggested Retail Price
#WV-AWS	Single Pump Air/Water Separator	\$200.00
#CP-3	Control Panel – 3 Button- Vac / Air / Water	\$390.00
#CP-4	Control Panel – 4 Button- Vac / Vac / Air / Water	\$460.00
#CV22	Air Compressor and Vacuum Pump Stacking Rack	\$780.00

Shipping Dimensions:

WV3: 17" x 18" x 20"	65 lbs.
WV5: 17" x 18" x 20"	71 lbs.



Superb Vac

Wet-Ring Vacuum

The TPC Superb Vac wet ring vacuum pump offers a quiet operation for small to medium size dental practices. Our twin TPC Superb Vac wet ring vacuum pump provides vacuum suction when operating in peak work periods. The twin pump offers back-up protection to minimize downtime and costly interruption to work flow.

Standard Features

- 220V 50/60 Hz
- 2 3/8" air exhaust connection size
- 20Amp circuit breaker
- Noise level less than < 58 dB Single
- Noise level less than < 65 dB Twin
- 3/8" city water connection
- 3/4" inlet connection
- Stainless steel impeller
- Unique water recycling to save up to 80% water
- NFPA 99C level 3-compliant
- UL/CUL classified
- 5 year limited warranty

Shipping Dimensions: L" x W: x H"

WV6: 32" x 25" x 24" 188 lbs.

WV6R: 32" x 25" x 24" 188 lbs.

WV10: 32" x 25" x 24" 208 lbs.

Model	WV3 (Single)	WV5 (Single)	WV6 (Twin)	WV10 (Twin)
Water consumption without water recycling:	4L/min	4L/min	6L/min	6L/min
Water consumption with TPC water recycling:	.8L/min	.8L/min	1.0L/min	1.0L/min
Suction Rate	900L/min	1500L/min	1800L/min	3000L/min
Vacuum Level (1N Hg) Factory set to 10HG	8-15 HG	8-15 HG	8-15 HG	8-15 HG
Noise Level dB (A)	58	58	65	65
Horse Power	1.2 HP	2 HP	2.4 HP	4 HP
Voltage	110V / 220V	220V	220V	220V
Frequency	50/60Hz	50/60Hz	50/60Hz	50/60Hz
Max. users	3	5	6	10
Current (A)	8A	13A	8Ax2	13Ax2
Circuit Breaker (A)	20A	20A	20Ax2	20Ax2
Inlet Connection Size	3/4"	3/4"	1"	1"
Drain Connection Size	1 1/4"	1 1/4"	1 1/4"	1 1/4"
City Water Connection Size	3/8"	3/8"	3/8"	3/8"
Air Exhaust Connection Size	2 3/8"	2 3/8"	2 3/8"	2 3/8"
Inlet Water Pressure (PSI)	10Psi / 0.7bar	10Psi / 0.7bar	10Psi / 0.7bar	10Psi / 0.7bar
Ambient Temperature	2 C- 40	2 C- 40	2 C- 40	2 C- 40
Product Size (LxWxH) Inches	16.5x14x18	16.5x14x18	28x17x18	28x17x18
Product Weight (LBS)	62lbs	66lbs	176lbs	198lbs

Description	Model	Suggested Retail Price
Superb Vac(3) 2.4 HP (2x1.2HP)	WV6(Twin)	\$5,590.00
Superb Vac(3R) 2.4 HP (2x1.2HP) (with recycler)	WV6R(Twin)	\$5,990.00
Superb Vac(5) 4HP (2x2HP)	WV10(Twin)	\$6,590.00
Superb Vac(5R) 4HP (2x2HP) (with recycler)	WV10R(Twin)	\$6,990.00

Product includes the following:

6 Simultaneous users	✓	✓	✓	✓
10 Simultaneous users			✓	✓
Water recycler		✓		✓
220V 50/60Hz	✓	✓	✓	✓
Adjustable vacuum level from 8-15Hg	✓	✓	✓	✓
Low voltage control panel connections	✓	✓	✓	✓
Air Water Separator	✓	✓	✓	✓

Options	Model	Suggested Retail Price
#WV-AWS	Single Pump Air/Water Separator	\$200.00
#CP-3	Control Panel – 3 Button- Vac / Air / Water	\$390.00
#CP-4	Control Panel – 4 Button- Vac / Vac / Air / Water	\$460.00
#CV22	Air Compressor and Vacuum Pump Stacking Rack	\$780.00



OMC 2375CV-SL

Orthodontic Mobile Delivery Cabinet



Optional OMC 2200
Monitor Bracket



OMC2375CVSL



Artic

OMC-ST81



White

OMC-ST82



Cream

OMC-ST85



Bamboo

OMC-ST86

Optional hard surface stone top



Rear compartment
4" W X 12"D X 20" H

Function:

This self-contained orthodontic mobile delivery cabinet offers a pullout breadboard, two instrument drawers, one medium and two large storage drawers for materials and supplies that fully extend and quickly remove for easy cleaning. In addition, this cabinets provides a large open space for accessories with convenient access from the front. The oversized dual-caster wheels, makes positioning of the cabinet simple and easy on all floor surfaces, including carpet.

Standard Cabinet Features:

- Five easy to remove and clean full extension drawers, and one pull-out writing surface.
- High quality hardware throughout
- Oversized caster wheels with LOCKS
- Four stationary handles for easy cart positioning
- A removable counter - top plastic tray

Standard Control Features:

- 3 HP Automatic selection
- 3-way syringe
- Vacuum Package with Saliva Ejector and HVE
- Self contained water bottle system
- Variable speed disc-type foot control
- Water coolant on/off switch with flow control
- 1 Year warranty
- **Self contained dual compressor**

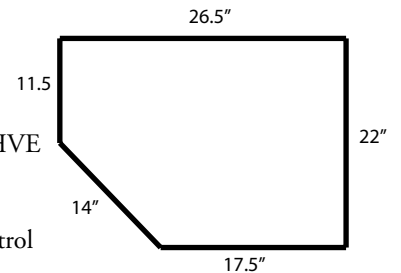

Description

Orthodontic Mobile Delivery Cabinet (Self contained)
Orthodontic Mobile Delivery Cabinet (Self contained)

Model

OMC2375CV-SL
OMC2375CV(No Scaler or LED curing light)

Suggested Retail Price

\$4,900
\$4,090

Options:

OMC2200	LCD Monitor Bracket W/ Post	\$300.00
OMC-ST81	Optional Stone Surface on OMC 2375, Color Artic	\$380.00
OMC-ST82	Optional Stone Surface on OMC 2375, Color White	\$380.00
OMC-ST85	Optional Stone Surface on OMC 2375, Color Cream	\$380.00
OMC-ST86	Optional Stone Surface on OMC 2375, Color Bamboo	\$380.00

Packing Dimensions: 32" x 28" x 41" / 180 lbs CV-SL model

PC 2700

Portable Dental Chair Package



PC 2740
Dr. Stool



PC 2720
Patient Chair

PC 2760
Operatory Light

PC 2780
Stainless Steel tray
&
spit cup



PC 2750
Portable Operatory LED
light with tripod base



Description

Portable Dental Chair Package

(Includes Patient Chair, Light, Stool, Tray, Spittoon & heavy duty Carry bags)

1 Year Warranty

Model

PC 2700

Suggested Retail Price

\$1,890

Options Model

PC 2720 Portable Patient Chair with Carrying Bag

PC 2740 Portable Dr. Stool with Carrying Bag

PC 2760 Portable Operatory Light chair mounted

PC 2780 Stainless Steel tray and spit cup

PC 2790 Portable chair heavy duty carry bag

PC 2795 Stool heavy duty carry bag

PC2750 Portable LED Operatory Light with Tripod Base with Carrying Bag

Suggested Retail Price

\$930.00

\$480.00

\$260.00

\$260.00

\$190.00

\$100.00

\$378.00

Shipping Dimensions: PC 2700

Packing Dimensions: 49" x 12" x 24" / 73 lbs

PC 2740

Packing Dimensions: 49" x 12" x 24" / 17 lbs

PC 2750

Packing Dimensions: 49" x 12" x 24" / 10 lbs.



PC 2630

Portable Delivery System

- PC2930: Includes
- LED Curing light
 - Piezo Scaler



PC2630



PC2930



The **PC2630** is a fully self contained air dental system. Quick and easy to setup and operate. Ready for travel. Tornado HP available upon request. Ask for details.

Description	Model	Suggested Retail Price
-------------	-------	------------------------

Portable Dental System	PC2630	\$2,050
Portable Dental System W/ Scaler & LED Curing Light	PC2930	\$2,900

Package Includes the following

• 4 hole or 2 hole instrument tubings (specify)	✓	✓
• 3 way syringe	✓	✓
• Saliva ejector	✓	✓
• Self contained water bottle system	✓	✓
• Self contained oil less compressor (580W / 7L)	✓	✓
• Foot control	✓	✓
• Air venturi vacuum system	✓	✓
• Transportation case with pull out handle.	✓	✓
• 1 year warranty	✓	✓
• Built In Scaler		✓
• Built In Curing Light		✓

Options:

	Retail
A800N-1 Advance 800 piezo scaler – built in	\$530.00
INSTALL-1 LABOR (To Install Build-In Piezo Scaler with Additional Holder on PC2630)	\$230.00
53012-INSTL Female Quick disconnect (factory installed)	\$140.00

Shipping Dimensions: pc2630

Packing Dimensions: 16" x 20" x 28" / 60 lbs

Shipping Dimensions: pc2930

Packing Dimensions: 16" x 20" x 28" / 65 lbs

PC 2635

Portable Delivery System



PC2635

The **PC2635** is a portable, self contained delivery system suitable for use in-office, nursing homes, hospitals, or wherever any off-site dentistry is required. The PC2635 is a lightweight, portable system that is easily transported. Air and water supply are included on the PC2635 portable dental system. Optional Tornado High and Slow speed handpieces are available.

<u>Description</u>	<u>Model</u>	<u>Suggested Retail Price</u>
Portable Dental System	PC2635	\$1,598

Package Includes the following

- 4 hole or 2 hole instrument tubings (specify) ✓
- 3 way syringe ✓
- Self contained oil less compressor (580W / 7L) ✓
- Foot control ✓
- Automatic handpiece flush System ✓
- Built in carrying handle ✓
- Self contained water bottle system ✓
- 1 year warranty ✓

Shipping Dimensions:

Packing Dimensions: 23" x 17" x 22" / 75 lbs



PC 2530

Mobile Vacuum System

- Moves with Ease
- Efficient
- Simple Maintenance
- Perfect Backup
- Cost Effective
- Compact



PC2530

Specifications

- Electrical: 7/8 Horsepower
115 VAC, 50/60 Hz
230 VAC, 50/60 Hz
4.0 Amps
- Sound: 70 db
- Motor: Variable speed control
- Construction: Metal Case
- Vacuum: 80" of water (6" of Hg)
- Airflow: 75 cfm
- Canister: 2 Liter
- Dimensions: 14" L x 12" W x 31" H
- Shipping: Freight

The PC 2530 Mobile Vac System is a portable, self contained vacuum system suitable for use by the dentist in a temporary location or when it is not feasible to install a central vacuum system.

Description	Model	Suggested Retail Price
Mobile Vacuum System	PC2530	\$1,900

Package Includes the following

- 2 HVE and 1 SE Valves ✓
- Drain Line ✓
- 2 SE suction tips ✓
- Power cord ✓
- Solids trap ✓
- 1 year warranty ✓

Shipping Dimensions:

Packing Dimensions: 17" x 25" x 37" / 95 lbs



MC3600CV(SL)

Mirage Mobile Delivery Cart



Clean Water Bottle



Waste Bottle



MC3600CVSL

- Moves with ease
- Efficient
- Simple maintenance
- No plumbing required
- Cost effective
- Compact

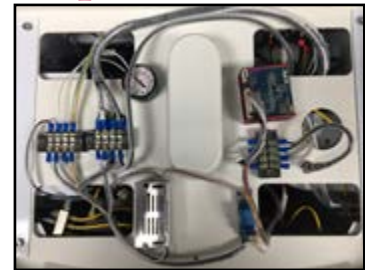

Specifications

- Electrical: (2) X 550W head
115 VAC, 50/60 Hz
6.0 Amps
- Sound: 68 db
- Motor: Oil less air compressor
- Construction: Metal Case
- Vacuum: 80" of water (6" of Hg)
- Max psi: 115 PSI / 40L per min
- Canister: 1 Liter
- Shipping: Freight only

Physical Dimensions

31"H x 20"W x 16"D

The MC3600CV (SL) is a self contained mobile delivery cart suitable for use by the dentist in a location when it is not feasible to connect to central plumbing

Description	Model	Suggested Retail Price
Mirage Mobile Delivery Cart	MC3600CV	\$3,700
Mirage Mobile Delivery Cart	MC3600CV-SL	\$4,400

Package Includes the following

• 3 way syringe, saliva ejector, hve	✓	✓
• 2 handpiece positions	✓	✓
• Variable speed disc-type foot control	✓	✓
• Self contained (dual compressor)	✓	✓
• Clean water Bottle	✓	✓
• Waste water Bottle	✓	✓
• Advance 800 Built in Piezo Scaler	✓	✓
• LED 39 Built in Curing Light	✓	✓
• Dual 110v outlet (rear of cart)	✓	✓
• 1 year warranty	✓	✓

Shipping Dimensions:

Packing Dimensions: 39" x 27" x 23" / 130 lbs



ProClean

Extra Oral Suction System



Benefits:

- Captures and destroys viruses, germs and microorganism aerosols and droplets generated from high speed drilling and ultrasonic scaling at chairside
- Captures mercury vapors from amalgam removal
- Captures BPA particulates from composite material
- Neutralizes noxious chemical disinfectants odors and VOC gases
- Neutralizes smoke plum during dental laser and electrosurgery procedures
- Captures air abrasion and micro-etching dust

Filtration Process:

- Moisture Absorption Filter: Absorption of medium sized water droplets, moisture, aerosols and oils
- 2 Layer HEPA Filter: H13 Fine particle filter. Filtration of fine and ultra-fine dust, bacteria, viruses, fungi and prions. Efficiency: >99.97% @ >0.3 microns
- UV-C Germicidal Lamp: Disinfection and sanitation of air beyond filtration. Power: 10 watts, Wavelength: 254.7 nm
- Cold Plasma Ionizer: Eliminates particles as small as 0.01 microns including viruses, odor molecules and cigarette smoke

Technical Specifications:

Power Requirements:	100-120V AC, 50/60 Hz (International: 220-240V AC, 50/50 Hz)
Power	1200 Watts
Suction Pressure:	29 Kpa
Suction Flow:	4,000L/min (5Kpa)
Noise Level:	<65dB
New Weight;	64 lbs
Air Intake:	Segmented rotary arm with removable hood- 71.5" length x 2.5" diameter
UC-C Lamp Sterilization:	254.7 nm, 10 Watt
Plasma Disinfection:	5,000V
HEPA Grade H13:	0.3 micron, > 99.97%

Features:

- Kills 99.97% of viruses, germs and microorganisms
- Adjustable suction power
- Segmented rotary arm with replaceable wide-mouth suction hood
- Medical grade filtration system
- 2-year warranty

Description	Model	Suggested Retail Price
ProClean Extra Oral Suction System	PC2800	\$1,590

Package Includes the following

- Power Cord ✓
- Operation Manual ✓
- 2 year warranty ✓

Options:

		Retail
#PC2800-SYNFLTR	Replacement washable synthetic filter	\$9.00
#PC2800-HEPA13SML	Replacement HEPA-13 Small Filter	\$69.00
#PC2800-UVLAMP	Replacement UV Lamp	\$69.00
#PC2800-PLSMAGEN	Replacement Plasma Generator	\$69.00
#PC2800-HEPA13LG	Replacement HEPA-13 Large filter	\$95.00
#PC2800-Motor	Replacement Suction Motor	\$390.00

Shipping Dimensions:

ProClean : 29" x 19" x 38" / 85 lbs

Mirage

Operatory Stools



Model SS-5105



Dimensions:

vertical adjustment range: 0" – 3.5"
 Seat width: 16"
 Seat height ranges: 24.5" – 31.8"
 5-Leg base diameter: 24"
 Shipping dimensions: 22" x 21" x 15" / 23 lbs.

Model DR-1102



Dimensions:

Backrest vertical adjustment range: 0" – 3.25"
 Seat width: 18"
 Seat height ranges: 19.5" – 24.8"
 5-Leg base diameter: 24"
 Shipping dimensions: 23" x 23" x 17" / 33 lbs.

Model DR-7000



Dimensions:

Backrest vertical adjustment range: 0" – 3.25"
 Seat width: 18.3"
 Seat height ranges: 19.5" – 24.8"
 5-Leg base diameter: 24"
 Shipping dimensions: 22" x 23" x 17" / 33 lbs.

Description

Model

Suggested Retail Price

Mirage saddle stool	SS-5105		\$650
Mirage doctor's stool		DR-1102	\$610
Solace doctor's stool		DR-7000	\$778

Stool Package includes the following:

Five-leg, ultra stable base, 24" diameter	✓	✓	✓
Gas cylinder lift for seat height adjustment	✓	✓	✓
Adjustable for right or left hand use	✓	✓	✓
Large, firm cushion seat	✓	✓	✓
Adjustable full ring foot rest	✓		
Dual wheel casters	✓	✓	
Adjustable anatomical body support bar	✓	✓	
Height adjustment	23" - 31"	19" - 23"	19" - 23"
16 Upholstery color choices	✓	✓	✓
Seat tilt	✓	✓	
Optional adjustable armrest		✓	✓
1 year warranty	✓	✓	✓

Options *Specify Color And Product Code*

DR1102-9	Replacement DR1102 Seat Cushion ONLY Duration Vinyl	\$160.00
DR1102-11	Replacement DR1102 Chair Back Cushion ONLY Duration Vinyl	\$140.00
DR1102-Vinyl-UC	Upcharge Non Standard Vinyl DR1102 Upholstery upcharge	\$148.00
DR-1102-ULTR-UC	Upcharge Ultra leather DR1102 Upholstery upcharge	\$280.00
DR-7000-Vinyl-UC	Upcharge Non Standard Vinyl DR7000 Upholstery upcharge	\$150.00
DR-7000-ULTR-UC	Upcharge Ultra leather DR-7000 Upholstery upcharge	\$290.00
SS-5105-Vinyl-UC	Upcharge Non Standard Vinyl SS5105 Upholstery upcharge	\$160.00
SS-5105-ULTR-UC	Upcharge Ultra leather SS5105 Upholstery upcharge	\$300.00



Mirage

Operatory Stool

Model AS-1101



Dimensions:
 Backrest vertical adjustment range: 0" – 3.25"
 Seat width: 18.5"
 Seat height ranges: 23" –30"
 5-Leg base diameter: 24"
 Packing dimensions: 24" x 23" x 21" / 42 lbs.

Model HY-5107



Dimensions:
 Backrest vertical adjustment range: 0" – 3.25"
 Seat width: 17"
 Seat height ranges: 20" –25"
 5-Leg base diameter: 24"
 Packing dimensions: 22" x 21" x 15" / 30 lbs.

Model DRSA-7100-DU100



Dimensions:
 Backrest vertical adjustment range: 0" – 3.25"
 Seat width: 18"x15.7"
 Seat height ranges: 20" –25"
 5-Leg base diameter: 24"
 Packing dimensions: 24" x 23" x 22" / 45 lbs.
 Only Available in black DU-100

Description

Model

Suggested Retail Price

Mirage Assistants stool	AS-1101		\$778
Mirage Hygiene stool		HY-5107	\$650
Mirage Mica Surgeon Stool		DRSA-7100-DU100	\$1,098

Stool Package includes the following:

Five-leg, ultra stable base, 24" diameter	✓	✓	✓
Gas cylinder lift for seat height adjustment	✓	✓	✓
Large, firm cushion seat	✓	✓	✓
Durable tile / carpet Casters	✓	✓	✓
Adjustable full ring foot rest	✓		
Adjustable for right or left handed use	✓		
Adjustable anatomical body support bar	✓		
Seat tilt		✓	✓
Height adjustment	22" - 29"	19" - 23"	19"-25"
Adjustable armrest			✓
Available in 4 colors (DU-18, DU-100, DU-116, DU-220)		✓	DU-100 Black only
1 year warranty	✓	✓	✓

Options *Specify Color And Product Code*

AS1101-16	Replacement AS1101 Seat Cushion ONLY Duration Vinyl	\$160.00
AS1101-21	Replacement AS1101 Chair Back Cushion ONLY Duration Vinyl	\$140.00
AS1101-18	Replacement AS1101 Abdominal Bar Cushion ONLY Duration Vinyl	\$125.00
AS1101-Vinyl-UC	Upcharge Non Standard Vinyl AS1101 Upholstery Upcharge	\$170.00
AS1101-ULTR-UC	Upcharge Ultra leather AS1101 Upholstery Upcharge	\$320.00



Laguna

Operatory Stool

Model DR-5045



Dimensions:

Backrest vertical adjustment range: 0" – 3.25"
 Seat width: 18"x15.7"
 Seat height ranges: 20" –25"
 5-Leg base diameter: 24"
 Packing dimensions: 24" x 23" x 20" / 33 lbs.

Model AS-5047



Dimensions:

Backrest vertical adjustment range: 0" – 3.25"
 Seat width: 18.5"
 Seat height ranges: 23" –30"
 5-Leg base diameter: 24"
 Packing dimensions: 24" x 23" x 20" / 42 lbs.

Description

Model

Suggested Retail Price

Laguna Assistants stool	AS-5047	\$498
Laguna Hygiene stool	DR-5045	\$398

Upholstery Selections:



Stool Package includes the following:

Five-leg, ultra stable base, 24" diameter	✓	✓
Gas cylinder lift for seat height adjustment	✓	✓
Large, firm cushion seat	✓	✓
Durable tile / carpet Casters	✓	✓
Adjustable full ring foot rest	✓	
Adjustable for right or left handed use	✓	
Adjustable anatomical body support bar	✓	
Seat tilt		✓
Height adjustment	22" - 29"	19" - 23"
Adjustable armrest		
1 year warranty	✓	✓

Options *Specify Color And Product Code*

Mirage

X-ray Chair



Model XR-6101

Dimensions:

- Seat width: 21"
- Seat height ranges: 21.5" – 27.5"
- Base diameter: 24"
- Packing dimensions: 31" x 20" x 11" / 45 lbs.
- 8" x 8" x 18" / 15 lbs.
- 24" x 24" x 4" / 28 lbs.

Description	Model	Suggested Retail Price
Mirage Xray chair	XR-6101	\$1,450

X-ray stool Package includes the following:

- Adjustable headrest ✓
- Gas cylinder lift for seat height adjustment ✓
- Pneumatic pump on base ✓
- Large, firm cushion seat ✓
- Large diameter base ✓
- Height adjustment ✓ 21.5" - 27.5"
- 16 Upholstery color choices ✓
- Arm rest ✓
- Leg rest ✓
- 1 year warranty ✓

Options

XR-6101-8-C	Replacement XR6101 Duration Vinyl Seat Cushion ONLY	\$160.00
XR-6101-9-C	Replacement XR6101 Duration Vinyl Chair Back Cushion ONLY	\$190.00
XR-6101-10-C	Replacement XR6101 Duration Vinyl Headrest Cushion ONLY	\$110.00
XR-6101-Vinyl-UC	Upcharge Non Standard Vinyl XR6101 Upholstery Upcharge	\$316.00
XR-6101-ULTR-UC	Upcharge Ultra leather XR6101 Upholstery Upcharge	\$500.00



Lustruos LED

Operator Light



Model #L550-LED



Model L570-LED
Ceiling mounted

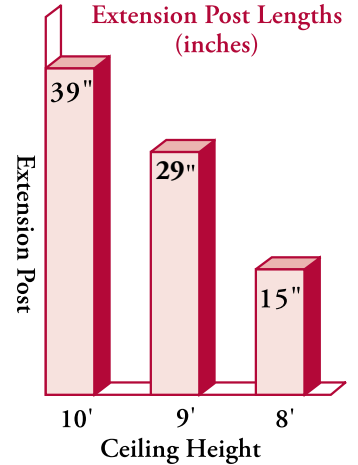

Packing Dimensions (L x W x H)	Weight
L900-08: 15 x 3 x 3	3 lbs.
L900-09: 30 x 3 x 3	5 lbs.
L900-10: 44 x 4 x 4	7 lbs.

#LP48 Light Post must be ordered if dental light is ordered separately
Specifications:

Dimmer mode:	From 8,000-30,000 Lux	Light intensity (Lux):	8,000 - 30,000 Lux @ 700mm 5,000 Kelvin
Input voltage:	110V/220V, 60/50 Hz	Cooling System:	Static Heat sink (no fan)
Output voltage:	24 Volts AC / DC	Illumination area:	100mm x 180mm @ 700mm

Description	Model	Suggested Retail Price
Lustrous LED Post Mount Operator Light	L550-LED	\$1,230
Lustrous LED Ceiling Mounted Light (specify 8', 9' or 10' ceiling)	L570-LED	\$1,770

Package includes the following:

Input voltage 24 Vac 50/60Hz	✓	✓
2 year warranty	✓	✓
Manual toggle / Motion sensor standard	✓	✓
PoliBlock Filter mode	✓	✓

Options:	Retail
RLL-PS 110 - 240 V Power supply in 24 V out	\$78.00
LP-48 48" light post	\$180.00
L690-08 Ceiling post for 8' ceiling height	\$192.00
L690-09 Ceiling post for 9' ceiling height	\$192.00
L690-010 Ceiling post for 10' ceiling height	\$192.00
L690-011 Ceiling post for 11' ceiling height (special order)	\$240.00

Packing Dimensions (L x W x H)	Weight
L550: 17 x 15 x 7	7 lbs.
L570: 17 x 15 x 7	7 lbs.
L600 Arm: 34 x 11 x 5	10 lbs.
L690 Arm: 32 x 18 x 6	18 lbs.



Lucent LED

Operator Light



Model #L600-LED



Model L690-LED
Ceiling mounted
Lucent LED
operator light.

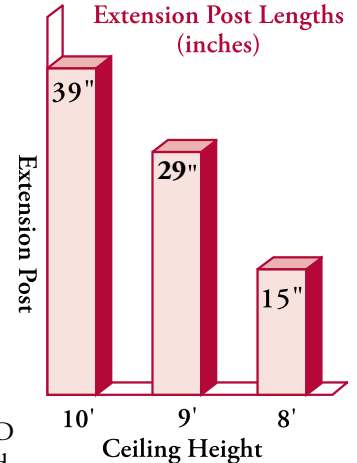

Packing Dimensions (L x W x H)	Weight
L900-08: 15 x 3 x 3	3 lbs.
L900-09: 30 x 3 x 3	5 lbs.
L900-10: 44 x 4 x 4	7 lbs.

#LP48 Light Post must be ordered if dental light is ordered separately
Specifications:

Absorbed Power:	Max 8vA
Input voltage:	110V/220V, 60/50 Hz
Output voltage:	24 Volts AC / DC

Light intensity (Lux):	3,000 - 35,000 Lux @ 700mm
Cooling System:	Static Heat sink (no fan)
Illumination area:	100mm x 180mm @ 700mm

Description	Model	Suggested Retail Price
Lucent LED Post Mount Operator Light	L600-LED	\$1,430
Lucent LED Post Mount Operator Light with motion sensor	L625-LED	\$1,610
Lucent LED Ceiling Mounted Light (specify 8', 9' or 10' ceiling)	L690-LED	\$1,990
Lucent LED Ceiling Mounted Light (specify 8', 9' or 10' ceiling) with motion sensor	L695-LED	\$2,170

Package includes the following:

Input voltage 110V	✓	✓	✓	✓
2 year warranty	✓	✓	✓	✓
Dimmer Mode	✓	✓	✓	✓

Options:

Options	Retail
RLL-H04 Replacement LED light optical bulb group	\$350.00
RLL-H06 Replacement light handle (Left and Right)	\$118.00
RLL-H01 Replacement shield	\$110.00
RLL-H03 Replacement reflector / set of 2	\$119.00
RLL-PS 110 - 240 V Power supply in 24 V out	\$78.00
LP-48 48" light post	\$180.00
L690-08 Ceiling post for 8' ceiling height	\$192.00
L690-09 Ceiling post for 9' ceiling height	\$192.00
L690-010 Ceiling post for 10' ceiling height	\$192.00
L690-011 Ceiling post for 11' ceiling height (special order)	\$240.00

Packing Dimensions (L x W x H)	Weight
L600: 34 x 11 x 5	10 lbs.
L690: 32 x 18 x 6	18 lbs.

Packing Dimensions (L x W x H)	Weight
Light Head: 14 x 9 x 14	7 lbs.



Radiant LED

Operator Light



Radiant light handles are removable and sterilizable

R6101-LED

#LP48-RI Light Post must be ordered if dental light is ordered separately
Specifications:

Absorbed Power:	Max 8vA	Light intensity (Lux):	3,000 - 35,000 Lux @ 700mm
Input voltage:	110V/220V, 60/50 Hz	Cooling System:	Static Heat sink (no fan)
Output voltage:	24 Volts AC / DC	Illumination area:	100mm x 180mm @ 700mm
Bulb type:	LED		

Description	Model	Suggested Retail Price
Radiant LED Operator Light	R6101-LED	\$1,770
Radiant LED Operator Light with motion sensor	R6105-LED	\$1,950

Package includes the following:

Input voltage 110V - 240 Vac	✓	✓
2 year warranty	✓	✓
Dimmer Mode	✓	✓

Options:	Retail
RLL-H04 Replacement LED light optical bulb group	\$350.00
RLL-H06 Replacement light handle (Left and Right)	\$118.00
RLL-H01 Replacement shield	\$110.00
RLL-H03 Replacement reflector / set of 2	\$119.00
RLL-PS 110 - 240 V Power supply in 24 V out	\$78.00
LP-48-RI 48" light post	\$180.00
408500 Wall Mount Bracket	\$590.00

Packing Dimensions (L x W x H)	Weight
Arm: 17 x 6 x 36	14 lbs.
Head: 14 x 14 x 9	8 lbs.

Nylon Bushing

#LP-RI-S Included with models
 R6101-LED, R6105-LED

- OD 1 7/8"
- ID 1 3/8"





Luminous

LED Operator Light
with *PoliBlock Filter*



#L7601-LED

Luminous light handles are removable and sterilizable

#LP48-RI Light Post must be ordered if dental light is ordered separately
Specifications:

Absorbed Power:	Max 8vA	Light intensity (Lux):	3,000 - 35,000 Lux @ 700mm
Input voltage:	110V/220V, 60/50 Hz	Cooling System:	Static Heat sink (no fan)
Output voltage:	24 Volts AC / DC	Illumination area:	100mm x 180mm @ 700mm
Bulb type:	LED		

Description	Model	Suggested Retail Price
Luminous LED Operator Light	L-7601-LED	\$2,650
Luminous LED Operator Light with motion sensor	L-7605-LED	\$2,850
Luminous LED Operator Light Ceiling Mount	L-7901-LED	\$3,990

Package includes the following:

Input voltage 110V - 240 Vac	✓
2 year warranty	✓

Options:

LU-PB	Antipolymerization Filter "Poli-Block"	Retail
		\$130

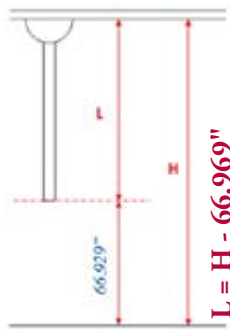

*** Ceiling light extension post must be cut at the time of installation.**

Nylon Bushing

#LP-RI-S Included with models
 • OD 1 7/8" R6101-LED, R6105-LED
 • ID 1 3/8"



Packing Dimensions (L x W x H)	Weight
Light Arm: 17" x 6" x 36"	18 lbs.
Light Head: 14 x 14 x 9	



PC2750

Portable LED Operatory Light

W/ Tripod Base



PC2750

Specifications:

Absorbed Power: 10 Watts

Max

Input voltage: 110V/220V, 60/50

Hz

Output voltage: 12 Volts

DC

Bulb type: LED

Light intensity (Lux): 16,145 Lux @ 61cm

Cooling System: Static Heat sink (no fan)

Color Temperature: 6,500 K

Lamp Height: 41" - 69"

Boom Length: 41"

Duty cycle: Continuous

LED life: 10,000 hours min

Intensity adjustment: 0 - 100%

Normal working distance: 16" - 36"



Description

Model

Suggested Retail Price

Portable LED operatory light with tripod base

PC2750

\$378.00

Package includes the following:

Input voltage 110V - 240 Vac Power supply



Carry bag



Options:

PC-2760-PS Replacement power supply for portable LED operatory light

Retail

\$38.00

PC-2798 Carry bag for portable LED operatory light

\$40.00

Packing Dimensions (L x W x H)	Weight
Light: 8" x 8" x 32"	10 lbs.



Mobile Cabinet Systems



Utility Mobile Cabinet

#TMC-180

- 14.5" W x 16" D x 32" H
- designed for ultrasonic scalers, curing lights, electrasurge, intraoral cameras, etc.
- 1 instrument drawer
- 2 adjustable shelves
- 1 year warranty
- shipping dimensions: 20" x 22" x 34" / 65 lbs.



Doctor's Mobile Cabinet

#TMC-140

- 21.5" W x 19" D x 32" H
- 4 instrument drawers
- 3 storage drawers
- 1 year warranty
- shipping dimensions: 33" x 22" x 24" / 110 lbs.



Assistant's "Alabama" Mobile Cabinet

#TMC-160

- 21.5" W x 19" D x 32" H
- sliding counter top with amalgamator well
- 1 instrument drawer
- 2 storage drawers
- side to side sliding counter
- 1 year warranty
- shipping dimensions: 33" x 22" x 24" / 110 lbs.



Assistant's "North Carolina" Mobile Cabinet

#TMC-120

- 21.5" W x 19" D x 32" H
- solid top with pull handle
- amalgamator well drop leaf door
- 3 instrument drawers
- 1 storage drawer
- 1 year warranty
- shipping dimensions: 33" x 22" x 24" / 110 lbs.



- White will be shipped if color choice not indicated on purchase order
- Mobile cabinets ship on pallet via freight carrier

Description	Model (light grey)	Model (white)	Suggested Retail Price
Utility Mobile Cabinet	TMC-180-G	TMC-180-W	\$438
Doctor's Mobile Cabinet	TMC-140-G	TMC-140-W	\$898
Assistant's "Alabama" Mobile Cabinet	TMC-160-G	TMC-160-W	\$898
Assistant's "North Carolina" Mobile Cabinet	TMC-120-G	TMC-120-W	\$898
Assistant's "North Carolina" Mobile Cabinet RT pull out		TMC-120R-W	\$898

Package includes the following:

External surfaces of high pressure laminate with complimentary white interior surface for easy cleaning. Smooth flowing ball bearing glides. Durable casters. Color choice: white or light grey. 1 year warranty



17" LCD Monitor

Multimedia Monitor



#M017

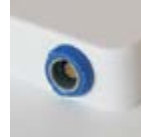

Intraoral Camera Port



Multimedia Input port

- Multimedia Monitor
- Glass panel
- 4:3 Screen
- DVD, Intraoral Camera READY!!
- Full 17" viewable TFT Active Matrix flat panel display
- Auto adjustment function
- Built-in dual speakers
- On screen display controls (OSDC)
- Recommended resolution: 1280 x 1024 (17")
- Universal 100-240 VAC, 50/60 Hz
- Gross weight: 11.6 lbs
- Includes: AC adapter, remote control, monitor handle, camera holder
- Connections: Video-in, HDMI, RGA-in, audio-in, DC-in, Flash Drive Media Player
- 1 year warranty

Description

Model

Suggested Retail Price

17" LCD multi media monitor

MO17

\$540

Shipping Dimensions 17" Monitor: 18" x 6" x 21" / 12 lbs.
(2/cs.) 19" x 12" x 22" / 27 lbs.

LCD Monitor Brackets

Monitor Brackets



WIC800

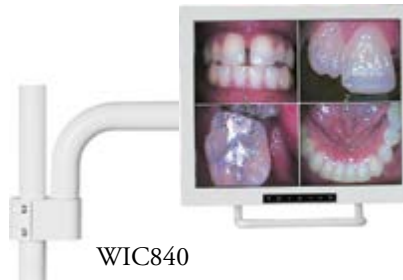

WIC840



WIC840

Standard LCD Monitor Bracket

- easily position the angle of your monitor for maximum comfort and productivity
- 4-way pivot adjustment
- standard 75mm spacing
- 1 Year warranty

Packing Dimensions:
11" x 7" x 6" 6 lbs.
(4/cs.) 15" x 12" x 11" 25 lbs.

Mirage Monitor Bracket

- 16" extension arm
- horizontal travel
- 4-way pivot adjustment
- standard 75mm spacing
- 1 Year warranty

Packing Dimensions:
15" x 10" x 5" 9 lbs.

Expansion Plate for 100mm Spacing

- 1 year warranty



M100mm

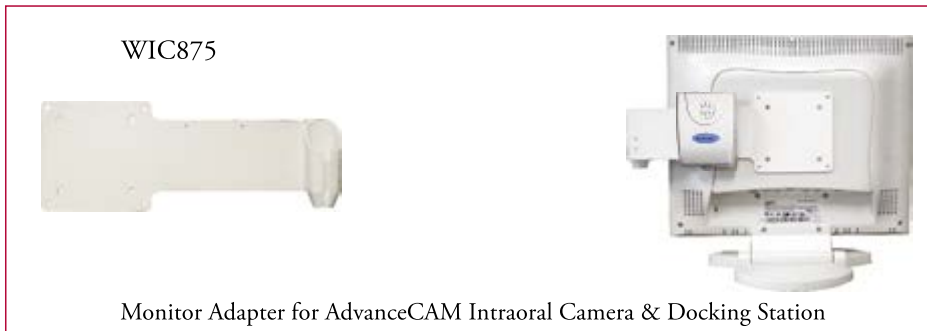

WIC875

Monitor Adapter for AdvanceCAM Intraoral Camera & Docking Station



WIC865

Standard and Deluxe LCD Monitor Bracket may be wall mounted

- 1 year warranty

Description	Model	Suggested Retail Price
Standard LCD Monitor Bracket	WIC800	\$118
Mirage LCD Monitor Bracket with 16" Extension Arm	WIC840	\$190
Expansion Plate for 100 mm spacing pattern	M100mm	\$22
Wall Plate Adapter	WIC865	\$90
Monitor Adapter for AdvanceCAM Intraoral Camera & Docking Station	WIC875	\$80

Super Thin

LED X-Ray Viwer



XV100 Viewer and
XV150-R Bracket



Mounted to Unit Head



Countertop Unit

- Viewing Area: 8.5" H x 11" W x 0.5" Thick
- Countertop, wall, or unit head mounted
- AC power source
- Sealed LED lights
- Instant illumination
- No grey in viewing area
- Viewing area accepts panoramic, cephalometric and regular size film
- 0.5" super thin viewer
- 1 year warranty



Wall Mounted



XV150
Assembly



XV150-R
*Mount to TPC
Mirage Unit (Round Arm)



XV150-F
*Mount to Flat Arm

Description

Model

Suggested Retail Price

Super Thin X-ray Viewer

XV100

\$140

Package Dimensions: 17" x 11" x 2" / 3 lbs.
(10/cs.) 17" x 11" x 19" / 28 lbs.

Options:

Retail

XV150-R	Xray viewer bracket (round cut-out) – mount to Mirage unit head (Round Arm)	\$80.00
XV150-F	Xray viewer bracket (flat cut-out) – mount to unit head (Flat Arm)	\$80.00
XV130	Replacement LED light strip	\$30.00
XV100-PSW	Viewer replacement power supply	\$20.00
XV100-CLIP	Viewer replacement Clip (3 Pack)	\$16.00

AIC5899



Specifications

- Imager Sony 1/4" CCD
- Capture Size 640 X 480
- Light Source 6 White LEDs
- Power USB 5VDC
- Frame Rate 30 fps MAX
- PC connection USB 2.0 Port

System Requirements

- Intel Pentium 4 .15 GHZ or Higher
- 512 MB RAM or higher
- Windows XP or higher
- USB 2.0 port



Description

Corded Direct USB Camera System

Model

AIC5899

Suggested Retail Price

\$790

Options:

- AIC500 Advance Cam Barriers, 500 / Box
- AIC930 Advance Cam Camera Holder
- AIC928-USB Advance Cam USB Camera Cable

Retail

- \$180.00
- \$30.00
- \$63.00

TPC

Advance Cam Intraoral Camera

Mini SD Card Camera System

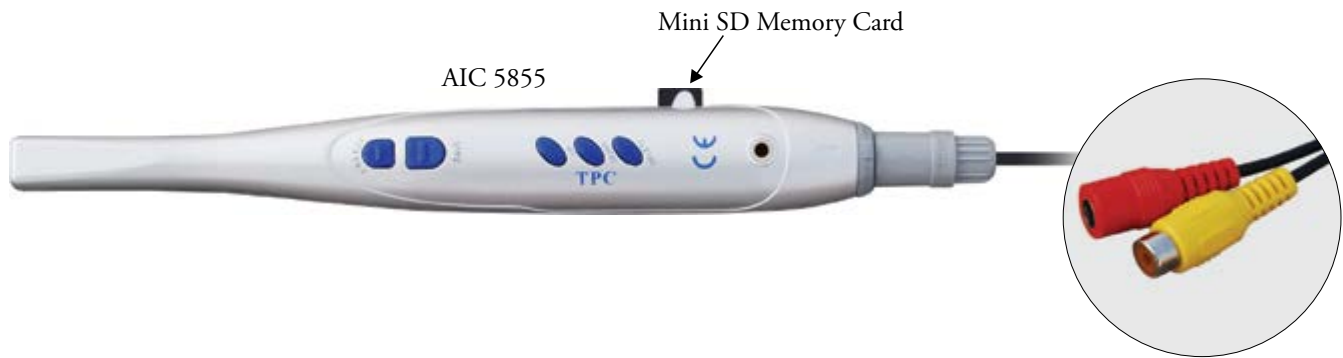

Specifications

- imager Sony 1/4" CCD
- capture Size 640 X 480
- light Source 6 White LEDs
- power 5VDC
- supported Mini SD Up to 16GB



Optional
AIC500

Description

Mini SD Card Camera System
(Both Corded and Cordless)

Model

AIC 5855-PKG
(Includes: AIC5855+5901+5111)

Suggested Retail Price

\$1,090

Options:

- AIC5855 Advance Cam Intraoral Camera (Corded Only) with Mini SD Card
- AIC5901 Mini SD Cam Power Supply
- AIC500 Advance Cam Barriers, 500 / Box
- AIC5111 Camera Mounted LCD Display 2.5"

Retail

\$760.00
\$150.00
\$180.00
\$140.00

TPC

Advance Cam Intraoral Camera

Corded Camera & Docking Station System



Specifications

- Imager Sony 1/4" CCD
- Capture Size 640 X 480
- Light Source 6 White LEDs
- Power USB 5VDC
- Frame Rate 30 fps MAX
- Connections AV & Composite VGA, HDMI
- Frequency 2.4 Ghz
- Memory Micro SD 4 gb

System Requirements

- Intel Pentium 4 .15 GHZ or Higher
- 512 MB RAM or higher
- Windows XP or higher
- Optional: USB 2.0 port



Description

Corded Camera & Docking Station System

Model

AIC5888-5925W-KT (includes AIC5888+AIC5925)

Suggested Retail Price

\$1,130

Options:

		Retail
AIC5888	Advance Cam Intraoral Camera	\$680.00
AIC5925	Advance Cam Docking Station	\$520.00
AIC930	Advance Cam Camera holder	\$30.00
AIC5111	Camera Mounted LCD Display 2.5"	\$140.00
AIC500	Advance Cam Barriers, 500 / Box	\$180.00
AIC966	Wifi adaptor	\$150.00



Specifications

- Imager Sony 1/4" CCD
- Capture Size 640 X 480
- Light Source 6 White LEDs
- Power USB 5VDC - 12VDC
- Frame Rate 30 fps MAX
- Connections USB, AV, Composite, VGA, HDMI
- Memory SD Memory Card 4 GB
- Frequency 5.8 Ghz



Description

Cordless Camera & Docking Station System

Model

WL-CAM+DS-PKG
(Includes: AIC5888+5925W+5900+5920)

Suggested Retail Price

\$1,380

Options:

		Retail
AIC5888	Advance Cam Intraoral Camera	\$680.00
AIC5925	Advance Cam Docking Station	\$520.00
AIC 5900	Wireless Transmitter	\$196.00
AIC5111	Camera Mounted LCD Display 2.5"	\$140.00
AIC500	Advance Cam Barriers, 500 / Box	\$180.00
AIC5920	Wireless Receiver	\$140.00
AIC966	Wifi Adaptor	\$150.00

17" LCD Monitor

Multimedia Monitor / Camera Combo



Features:

- Camera features a 1/4" High Definition image sensor
- 17" Monitor features a High Definition resolution of 1280 X 1024
- Full USB port allows for easy image transfer
- High Definition real time video input allows for quick playback and easy patient diagnosis
- Camera buttons are easily accessible to control capture and playback functions
- Camera is illuminated with six bright LEDs; giving the best contrast, definition and resolution
- Camera features an automatic gain control to automatically adjust the light intensity to the CCD
- Input supports: USB, VGA, HDMI and AV.
- Medial playback format includes: MP3 audio, MP4 video and JPG images
- Adjustments on monitor include: Contrast, brightness and color
- Monitor comes equipped with a medical grade tempered glass front panel to minimize scratches
- Monitor Language supported: English, Chinese, Spanish, German, Portuguese and Arabic
- 4gb memory card (included) allows for easy image transfer and patient file management
- Easy integration of LCD monitor with camera on the dental delivery unit due to no additional cabling needed



Description

Model

Suggested Retail Price

17" LCD monitor with integrated IO camera (corded) Includes: MO17, AIC5855A,	AIC2IN1W	\$1,200.00
17" LCD monitor with integrated IO camera (wireless) Includes: MO17, AIC5855A, AIC5920, AIC5900	AIC2IN1WL	\$1,490.00

Options:

Retail

AIC500	Advance Cam Barriers, 500 / Box	\$180.00
--------	---------------------------------	----------

Shipping Dimensions 17" Monitor: 18" x 6" x 21" / 12 lbs.
(2/cs.) 19" x 12" x 22" / 27 lbs.

17" LCD Monitor

Multimedia Monitor / Camera Combo

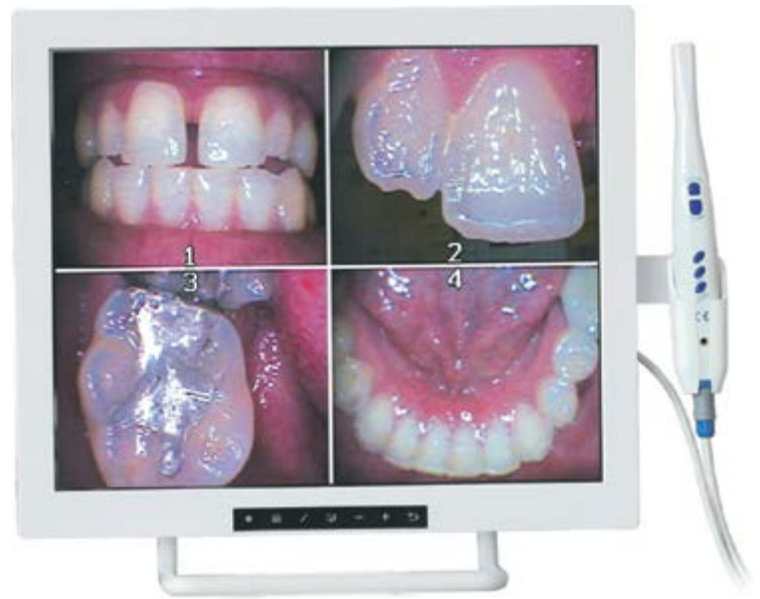

Features:

- Camera features a 1/4" High Definition image sensor
- 17" Monitor features a High Definition resolution of 1280 X 1024
- Full USB port allows for easy image transfer
- Camera buttons are easily accessible to control capture and playback functions
- Camera is illuminated with six bright LEDs; giving the best contrast, definition and resolution
- Camera features an automatic gain control to automatically adjust the light intensity to the CCD
- 5.8 GHz wireless transmission protocol
- Four channel wireless transmitter (AIC5900) and receiver (AIC5920)
- Input supports: USB, VGA, HDMI and AV.
- Media playback format includes: MP3 audio, MP4 video and JPG images
- Adjustments on monitor include: Contrast, brightness and color
- Monitor comes equipped with a medical grade tempered glass front panel to minimize scratches
- Monitor Language supported: English, Chinese, Spanish, German, Portuguese and Arabic
- 4gb memory card (included) allows for easy image transfer and patient file management
- Optional WIFI transmitter allows images to be displayed on stand alone LCD monitor and remote computers simultaneously for easy consultation and image management transfer.
- Easy integration of LCD monitor with camera on the dental delivery unit due to no additional cabling needed



Description	Model	Suggested Retail Price
17" LCD monitor with integrated IO camera corded Includes: MO17DS, AIC5888A	AIC3IN1W	\$1,500.00
17" LCD monitor with integrated IO camera wireless Includes: MO17DS, AIC5888 A, AIC5920, AIC5900	AIC3IN1WL	\$1,780.00

Options:

		Retail
AIC500	Advance Cam Barriers, 500 / Box	\$180.00
AIC966	Wifi Adapter	\$150.00

Shipping Dimensions 17" Monitor: 18" x 6" x 21" / 12 lbs.
(2/cs.) 19" x 12" x 22" / 27 lbs.

EMC - 900

eTornado Electric Motor System



eTornado Electric Motor Features:

- Fiber optic brushless electric motor
- Two programmable settings for each mode
- Push button control for easy operation
- Light weight, compact - ergonomical design
- Counter top system is easy to install and integrate
- Universal e-type connector compatible with most
- Speed range from 100 - 200,000 rpm

Specifications

- 2 General / Basic Endo Modes
- e-type attachment / coupling
- Manual reverse
- Unit dimensions
4.5"W X 5.25" D X 2.5"H
- Motor weight: 87 grams
- Motor Length: 50mm
- Input Voltage: 100 - 240 Vac
- Output Voltage: 30Vac

Easy to install and integrate with any dental unit.

Description	Model	Suggested Retail Price
e Tornado Electric Motor System - Counter top	EMC-900	\$1,900

Package includes the following:

e Tornado Electric Motor System - Counter top	✓
Power Pack	✓
HP Tubing	✓
E600 Electric Motor up to 40,000 rpm	✓

Options.

EMA150-FG	1:5 Friction Grip Attachment	\$1,160.00
EMA110-CA	1:1 Contra Angle Attachment	\$1,060.00
EMP30	Power Supply 30Vac, 4A for control box	\$140.00
EMC-600-T	Replacement HP tubing	\$390.00
EM-600	Replacement Motor	\$1,050.00

Shipping Dimensions: 11" x 11" x 5" / 5 lbs.

EMB - 901

eTornado Electric Motor System



Electric Motor With Tubing



eTornado Control Box



eTornado Touchpad

EMT-915

eTornado Electric Motor Features:

- Fiber optic brushless electric motor
- Two programmable settings for each mode
- Push button control for easy operation
- Light weight, compact - ergonomical design
- Built in system pre wired for easy installation
- Universal e-type connector compatible with most electric attachments
- Speed range from 100 - 200,000 rpm

Specifications

- 2 General / Basic Endo Modes
- e-type attachment / coupling
- Manual reverse
- Unit dimensions
4.5"W X 5.25" D X 2.5"H
- Motor weight: 87 grams
- Motor Length: 50mm
- Input Voltage: 100 - 240 Vac

Description

eTornado Built in Electric Motor System

Model

EMB-901

Suggested Retail Price

\$1,790

Package includes the following:

- eTornado Electric Motor System - Built in
- Power Pack
- HP Tubing
- E600 Electric Motor up to 40,000 rpm

- ✓
- ✓
- ✓
- ✓

Options

Options	Description	Price
EMA150-FG	1:5 Friction Grip Attachment	\$1,160.00
EMA110-CA	1:1 Contra Angle Attachment	\$1,060.00
EMB-901-PCB	Replacement Main PCB Board	\$790.00
EMB-600-T	Replacement HP tubing	\$390.00
EM-600	Replacement Motor	\$1050.00

Shipping Dimensions:

EMA-150FG

High Speed Contra Angle Attachment



EMA-110 CA

EMA-150FG

Description	Model	Suggested Retail Price
1:5 Friction Grip Attachment	EMA-150FG	\$1,160
1:1 Contra Angle Attachment	EMA-110CA	\$1,060
Package includes the following:		
Push Button Auto Chuck	✓	
Quatro Water Spray	✓	
Speed Range up to 200,000 rpm	✓	
Attachment to electric motor w/ E-type connection	✓	
Max Lux of 32,000	✓	

Shipping Dimensions:

High Speed Handpieces Overview

All High Speed Handpieces Use Ceramic Bearings



Fiber Optic Handpiece with Triple Water Spray



LQS(M) 666K - Kavo Type Handpiece



FSK6 - 6 Pin



LQS(M) 666N - NSK Type Handpiece



FSK5 - 5 Hole



FSN6 - 6 Pin



FSN5 - 5 Hole



LQS(M) 666S - Star Type Handpiece

Star Fiber Optic Swivel



or



Non-Fiber Optic Handpiece with Triple Water Spray



QS(M) 555K-Kavo Type Handpiece



SK4 - 4 Hole



QS(M) 555N-NSK Type Handpiece



SN4 - 4 Hole



QS(M) 555S-Star Type Handpiece

Star Non-Fiber Optic Swivel



Non-Fiber Optic Handpiece With Triple Water Spray Fixed Back End



S(M)506 M4

4 Hole



S(M)506 B2

2 Hole



Non-Fiber Optic Handpiece with Single Water Spray



QS(M) 222- TPC Type Handpiece



ST4 - 4 Hole



S(M) 333M4- TPC Type Handpiece

Fixed Back Handpiece - Does not need connector



S(M) 333B2- TPC Type Handpiece

Fixed Back Handpiece - Does not need connector



Fiber Optic Handpieces

Triple Water Spray / Push Button / Auto Chuck / Ceramic Bearing

Premius Series



Fiber Optic
w/Triple
Water Spray



LQS 666 (K,N,S)



Standard Head



LQM 666 (K,N,S)



Mini Head

FIBER OPTIC QUICK CONNECTORS

(Swivel)



FSK6 Kavo Type 6 Pin



FSK5 Kavo Type 5 Hole



FSN6 NSK Type 6 Pin

Description	Model	Suggested Retail Price
Kavo Type Fiber Optic HP <u>Standard</u> Head w/Triple Water Spray Fits Kavo Connector	LQS666K	\$710
Kavo Type Fiber Optic HP <u>Mini</u> Head w/Triple Water Spray Fits Kavo Connector	LQM666K	\$710
6 Hole (ISO-C) Fiber Optic Connector Fits Handpiece with KAVO "Multiflex" Quick Connector System	FSK6-LED	\$248
5 Hole (Midwest) Fiber Optic Connector Fits Handpiece with KAVO "Multiflex" Quick Connector System	FSK5	\$248
NSK Type Fiber Optic HP <u>Standard</u> Head w/Triple Water Spray Fits NSK Connector	LQS666N	\$710
NSK Type Fiber Optic HP <u>Mini</u> Head w/Triple Water Spray Fits NSK Connector	LQM666N	\$710
6 Hole (ISO-C) Fiber Optic Connector Fits Handpiece with NSK Quick Connector System	FSN6	\$248
Star Type Fiber Optic HP <u>Standard</u> Head w/Triple Water Spray Fits Star Connector	LQS666S	\$710
Star Type Fiber Optic HP <u>Mini</u> Head w/Triple Water Spray Fits Star Connector	LQM666S	\$710

Non-Fiber Optic Handpieces

Triple Water Spray / Push Button / Auto Chuck / Ceramic Bearing

Optimus Series



Non-Fiber Optic
w/Triple
Water Spray



QS 555 (K,N,S)



Standard Head



QM 555 (K,N,S)



Mini Head

NON-FIBER OPTIC QUICK CONNECTORS

(Swivel)



SK4 Kavo Type 4 Hole



SN4 NSK Type 4 Hole

Description	Model	Suggested Retail Price
Kavo Type Non-Fiber Optic HP <u>Standard</u> Head w/Triple Water Spray Fits Kavo Connector	QS555K	\$536
Kavo Type Non-Fiber Optic HP <u>Mini</u> Head w/Triple Water Spray Fits Kavo Connector	QM555K	\$536
4 Hole Non-Fiber Optic Connector Fits Handpiece with KAVO "Multiflex" Quick Connector System	SK4	\$134
NSK Type Non-Fiber Optic HP <u>Standard</u> Head w/Triple Water Spray Fits NSK Connector	QS555N	\$536
NSK Type Non-Fiber Optic HP <u>Mini</u> Head w/Triple Water Spray Fits NSK Connector	QM555N	\$536
4 Hole Non-Fiber Optic Connector Fits Handpiece with NSK Quick Connector System	SN4	\$134
Star Type Non-Fiber Optic HP <u>Standard</u> Head w/Triple Water Spray Fits Star Connector	QS555S	\$536
Star Type Non-Fiber Optic HP <u>Mini</u> Head w/Triple Water Spray Fits Star Connector	QM555S	\$536

Non-Fiber Optic Handpieces (Standard Back End)

Triple Water Spray / Push Button / Auto Chuck / Ceramic Bearing



Triton Series



Non-Fiber Optic
w/Triple
Water Spray



S504 M4 / S506 M4



Standard Head



M504 M4 / M506 M4



Mini Head

Description	Model	Suggested Retail Price
Non-Fiber Optic HP <u>Standard</u> Head w/Triple Water Spray Standard Back End-4 Hole	S504M4 / S506M4	\$505
Non-Fiber Optic HP <u>Mini</u> Head w/Triple Water Spray Standard Back End-4 Hole	M504M4 / M506M4	\$505
Non-Fiber Optic HP <u>Standard</u> Head w/Triple Water Spray Standard Back End-2 Hole	S502B2	\$505
Non-Fiber Optic HP <u>Mini</u> Head w/Triple Water Spray Standard Back End-2 Hole	M502B2	\$505

Non-Fiber Optic Handpieces

Single Water Spray / Push Button / Auto Chuck / Ceramic Bearing

Nexius Series



Non-Fiber Optic
w/Single
Water Spray



QS 222 Standard Head



Standard Head



QM 222 Mini Head



Mini Head

NON-FIBER OPTIC QUICK CONNECTORS (Swivel)



ST4 TPC Type 4 Hole

Description	Model	Suggested Retail Price
Non-Fiber Optic HP (Standard Head) with Single Water Spray Fits TPC Connector	QS222	\$440
Non-Fiber Optic HP (Mini Head) with Single Water Spray Fits TPC Connector	QM222	\$440
4 Hole Non-Fiber Optic Connector Fits Handpiece with TPC Quick Connector System	ST4	\$80

Non-Fiber Optic Handpieces (Standard Back End)

Single Water Spray / Push Button / Auto Chuck / Ceramic Bearing

Nexius Series



Non-Fiber Optic
w/Single
Water Spray



S333M4 Standard Head



Standard Head



M333M4 Mini Head



Mini Head



P333M4 Pedo Head



Pedo Head

Description	Model	Suggested Retail Price
Push Button Autochuck (Standard Head) with Single Water Spray Standard Back End -4 Hole	S333M4	\$320
Push Button Autochuck (Mini Head) with Single Water Spray Standard Back End -4 Hole	M333M4	\$320
Push Button Autochuck (Standard Head) with Single Water Spray Standard Back End -2 Hole	S333B2	\$320
Push Button Autochuck (Mini Head) with Single Water Spray Standard Back End -2 Hole	M333B2	\$320
Push Button Autochuck (Pedo Head) Standard Back End -4 Hole	P333M4	\$320

Low Speed Handpieces

External Water Coolant

Internal Water Coolant

Exomus Series



ELM 744: Air Motor, Speed range up to 20,000 rpm, forward / reverse speed adjustment



ELS 736: Transmission 1:1, speed range up to 20,000 rpm



ELCA 760: Transmission 1:1, push button autochuck, for latch burs



ELCA 762: Transmission 1:1, latch type, for latch burs

Inximus Series



ILM 844: Air Motor, Speed range up to 20,000 rpm, forward / reverse speed adjustment, internal air/water coolant



ILS 836: Transmission 1:1, internal water spray



ILCA 860: Transmission 1:1, internal water spray, push button auto chuck for latch burs



Description

External Water Low Speed Complete package includes (air motor, straight nose cone HP, Push button contra angle HP)
 External Water Low Speed Complete package includes (air motor, straight nose cone HP, Latch type contra angle HP)
 Low Speed Motor, External Water, 20,000 rpm (4 hole)
 Low Speed Motor, External Water, 20,000 rpm (2 hole)
 Straight nose cone HP, 1:1
 Push button contra angle HP, Complete 1:1
 Latch type contra angle HP, Complete 1:1
 Internal Water Low Speed Complete package includes (air motor, straight nose cone HP, push button contra angle HP)
 Low Speed Motor (Internal Water) 20,000 rpm-4 hole
 Straight nose cone HP, 1:1
 Push Button Contra Angle HP, Complete 1:1

Model

ELK700-M4 \$770
 ELK702-M4 \$638
 ELM744-M4 \$330
 ELM722-B2 \$320
 ELS736 \$183
 ELCA-760 \$330
 ELCA-762 \$183
 ILK800-4 \$1,400
 ILM844-4 \$516
 ILS-836 \$496
 ILCA860 \$516

Suggested Retail Price

Prophy Aide

Hygiene Prophy Handpiece



Description

Model

Prophy Aide Hygiene Handpiece
 Prophy Aide Hygiene Handpiece
Package includes the following:

PH-777 (Red) **\$398**
 PH-777 (BLK) **\$398**

- 4 Hole fixed back end
- 5,000 RPM
- Twist open chuck
- 360 Head Swivel Capabilities
- Forward and Reverse operation

- ✓
- ✓
- ✓
- ✓
- ✓



Fiber Optic Light Source

Light Source Package



H 7070
Fiber Optic Light Bulb
Cartridge



H 7040
Fiber Optic 5-Hole Tubing



H 7020
Control Board



H 7045
Fiber Optic 6-Pin Tubing



H 7090
Fiber Optic Transform



H 7660 - 6 Pin

Package includes: H7020+H7045+H7090



H 7000 - 5 Hole

Package includes: H7020+H7040+H7070+H7090

Description	Model	Suggested Retail Price
TPC Fiber Optic Light Source System- 6 Pin Package includes: Control board, Fiber Optic HP Tubing, Transformer	H7660	\$270
TPC Fiber Optic Light Source System- 5 Hole Package includes: Control board, Fiber Optic HP Tubing, Transformer, Bulb Cartridge	H7000	\$310
TPC Fiber Optic Control Board (accepts two Fiber Optic HP Tubing)	H7020	\$142
TPC Fiber Optic HP Tubing-6 Pin, Grey	H7045	\$120
TPC Fiber Optic HP Tubing- 5 Hole, Grey	H7040	\$120
TPC Fiber Optic Light Bulb Cartridge LED	H7070-LED	\$58
TPC Fiber Optic Light Source Transformer	H7090	\$26

Replacement Turbines & Parts

Handpiece Replacement Parts

REPLACEMENT TURBINES

Item #	Description	Retail
TRT 110S	Replacement turbine fits Tornado HP LQS 666, QS 555, Standard Head	\$258
TRT 115M	Replacement turbine fits Tornado HP LQM 666, QM 555, Mini Head	\$258
TRT 120S	Replacement turbine fits Tornado HP S333, Standard Head	\$225
TRT 122S	Replacement turbine fits Tornado HP QS222, Standard Head	\$225
TRT 125M	Replacement turbine fits Tornado HP QM222, M333, Mini Head	\$225
TRT 130	Push button turbine fits Kavo Super Torque 630 B/C and 640 B/C	\$250
TRT 135	Push button turbine fit for Kavo Super Torque 647B and 649 B	\$250
TRT 140	Push button turbine fit for Kavo Bella Torque 639B/C and 642 B/C	\$250
TRT 145	Push button turbine fit for Kavo Mira 635 B	\$250
TRT 150	Push button turbine fit for Star 430 Series Handpiece	\$250
TRT 155	Turbine fit for Midwest Quiet Air L F.O & Non F.O. HP	\$250
TRT 160	Turbine fit for Midwest Tradition L F.O & Non F.O. HP	\$250
TRT 165	Turbine fit for Midwest Tradition F.O & Non F.O. HP	\$130
TRT 170	Turbine fit for Midwest XGT/Tradition PB F.O & Non F.O. HP	\$250

REPLACEMENT PARTS

Item #	Description	Retail
TRP 213	Replacement Light Bulb for FSK6 (Kavo Type Quick Connector)	\$27
TRP 215	Replacement Light Bulb for FSN6 (NSK Type Quick Connector)	\$27
TRP 220	Back Cap Removal Tool for LQS 666, QS 555	\$18
TRP 222	Back Cap Removal Tool for LQM 666, QM 555	\$18
TRP 224	Back Cap Removal Tool for QS 222	\$18
TRP 226	Back Cap Removal Tool for QM 222, M 333	\$18
TRP 228	Back Cap Removal Tool for S 333	\$7
TRP 231	Replacement Push Button Cap for LQS 666, QS 555	\$46
TRP 233	Replacement Push Button Cap for LQM 666, QM 555	\$46
TRP 235	Replacement Push Button Cap for QS 222	\$46
TRP 237	Replacement Push Button Cap for QM 222, M 333	\$46
TRP 239	Replacement Push Button Cap for S 333	\$46
TRP 240	Replacement O Ring for FSK6, FSK5, Sk4 (Pack of 5 (2 white, 3 black))	\$10



TRP 213 TRP 215



TRP 240

H6000

Handpiece Lubrication System



H6000
(3 high speed positions)

Product Features

- Economical, efficient and time-saving
- A fail-safe maintenance solution for your office
- Filtered air used to rotate handpieces for safety
- Care for most handpieces and all handpieces brands
- Disposable mist filtration system
- Solution level indicator
- Detachable door for easy cleaning of unit
- Easy replenishment of solution tank
- Air pressure guage
- Oil flow control valve

• Saves Time

• Simple to Operate

• Optimizes Performance



H6005

- 2 high speed positions
- 1 low speed E-type motor



H6025

- 1 high speed positions
- 2 low speed E-type motor



H6150-Kavo
kavo maintenance coupler



H6155-NSK
NSK maintenance coupler



H6165-W&H
W&H maintenance coupler



H6145-MW
Quick Connect for Midwest Slow Speed



H6160-BienAir
BienAir maintenance coupler



H6175-E-Type
4 Hole to E-Type Adaptor

Description

Model

Suggested Retail Price

H6000 Handpiece cleaning and lubrication system	H6000		\$1,390
H6005 Handpiece cleaning and lubrication system		H6005	\$1,450
H6025 Handpiece cleaning and lubrication system		H6025	\$1,490

Package includes the following:

3 high speed handpiece positions	✓		
2 high speed / 1 low speed E-type motor		✓	
1 high speed / 2 low speed E-type motor			✓
Mist filters (pack of 12)	✓	✓	✓
Lubrication fluid	✓	✓	✓
Air filter	✓	✓	✓

Options:

		Retail
H6125	Lubrication fluid	\$56.00
H6130	Mist filter (pack of 12)	\$21.00
H6135	Oil absorbent door strips (pack of 20)	\$16.70
H6150-Kavo	Kavo type HP adapter	\$102.50
H6155-NSK	NSK type HP adapter	\$102.50
H6160-BienAir	Bien Air type HP adapter	\$102.50
H6165-W&H	W&H type HP adapter	\$102.50
H6145-MW	Quick connect for Midwest Slow Speed	\$102.50
H6175-E-Type	4 Hole to E-Type Adaptor	\$102.50

Packing Dimensions: 17"L x 15"W x 18"H / 24 lbs.

Advance 2505

LED Bleaching System



Features

- Quiet fan operation
- Multi-arch whitening application
- Three high intensity LED's
- Digital display with audio feedback
- High power Blue and UV light emitting diodes
- Compact mobile stand for easy storage
- Adjustable bleaching time with microprocessor-controlled timer
- Smart auto-select power: 110-240 Volts AC, 50/60 Hz
- LED bleaching system includes illuminator, mobile base, adjustable arm, power cord & user manual
- 2 year warranty



ALED2505

Specifications:

Broad-spectrum:	395–490 nm
Light intensity:	1,500 mW/cm ²
Weight:	14 lbs.
Dimensions:	60" (H) X 20" (W)
Voltage output:	110-240 V / 50-60 Hz
Packing Dimensions:	21" x 21" x 6" / 14lbs.

Description

Advance 2505 LED Bleaching Light

Model

ALED 2505

Suggested Retail Price

\$1,350

Package includes the following:

- Advance 2505LED Bleaching Light
- Mobile stand
- AC power supply
- 2 Year warranty





LED 70N

Cordless Curing Light System

Specifications and Accessories

Switching Power Adapter

Power supply: AC 100-240V / 50-60 Hz
 Dimensions: 10"L x 2"W x 8"H

Hand Piece

Light source: 10W light emitting diode
 Wavelength: 430-490 nm
 Light Intensity: 2,000 mW/cm²
 Battery: Lithium ion



ALED-70

Features

- Low battery signal – visual and audible alarm
- Easy to read – LCD display
- High light intensity – 5 to 10 second cure
- No down time
- Flexibility – corded and cordless light cure
- Quiet fan – extends life of LED
- Sleep mode – conserves power, saves battery life
- Fast mode – 3 output modes 2,000 – 1,500 – 1,000
- Built-in radiometer

Standard Accessories

- LED 70 Handpiece
- Charging base
- 8mm light guide
- Eye protector
- Lithium ion battery
- Power supply
- User's manual

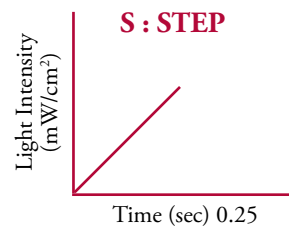
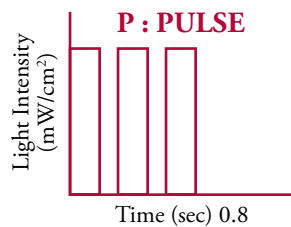
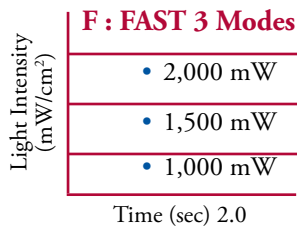

Description

LED 70 cordless curing light

Model

ALED-70

Suggested Retail Price

\$670

Package includes the following:

- LED 70 cordless curing light
- Charging base
- Protective eye-shield
- Countertop stand with power indicator
- 8mm Light Guide
- Built-in radiometer
- AC power supply



Options:

- P109-LG Replacement light guide (8mm)
- P208 Replacement protective eye-shield
- ALED 70N-BATT Replacement rechargeable battery for LED 70
- P117 11mm light guide

Retail

- \$82.00
- \$10.50
- \$84.00
- \$110.00

Shipping Dimensions: 11"L x 8"W x 4"H / 3 lbs.
 (10/cs.) 18"L x 12"W x 16"H / 25 lbs.



LED 60N

Cordless Curing Light System

Specifications and Accessories

Switching Power Adapter

Power supply: AC 100-240V / 50-60 Hz

Dimensions: 10"L x 2"W x 8"H

Hand Piece

Light source: 5W light emitting diode

Wavelength: 430-490 nm

Light Intensity: 1,400 mW/cm²

Battery: Lithium ion



ALED-60

Features

- Low battery signal – visual and audible alarm
- Easy to read – LCD display
- High light intensity – 5 to 10 second cure
- No down time
- Flexibility – corded and cordless light cure
- Quiet fan – extends life of LED
- Sleep mode – conserves power, saves battery life
- Built-in radiometer

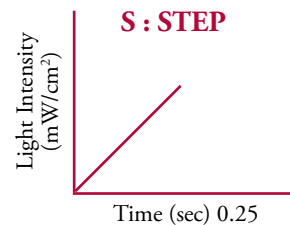
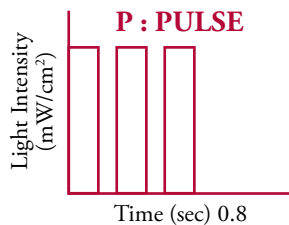
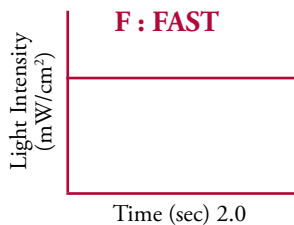

Standard Accessories

- LED 60 Handpiece
- Charging base
- 8mm light guide
- Eye protector
- Lithium ion battery
- Power supply
- User's Manual

Description

LED 60N cordless curing light

Model

ALED-60N

Suggested Retail Price

\$510

Package includes the following:

- LED 60N cordless curing light
- Charging base
- Protective eye-shield
- Countertop stand with power indicator
- 8mm light guide
- Built-in power radiometer
- AC power supply



Options:

		Retail
P109-LG	Replacement light guide (8mm)	\$82.00
P208	Replacement protective eye-shield	\$10.50
ALED 60N-BATT	Replacement rechargeable battery for LED 60	\$64.00
P117	11mm light guide	\$110.00

Shipping Dimensions: 11"L x 8"W x 4"H / 3 lbs.
(10/cs.) 18"L x 12"W x 17"H / 24 lbs.



LED 55N

Cordless LED Curing Light



Specifications

- Battery: Lithium Ion, DC 3.6-4.2V
- Power adapter: 90-250V AC, 50-60 Hz
- Charging base: 9V DC
- Power consumption: 5 W LED
- Wavelength range: 430-490 nm
- Light Intensity: 1,250 mW / cm²
- Dimensions: 7"L x 1"W x 1"H
- Weight: 160 g
- Warranty: 2 year

Benefits

- Ergonomic, light weight design
- High intensity output up to 1 hour before recharging
- Cordless for ultimate convenience
- Cures most materials in 5-10 seconds
- Curing time: 20 seconds per cycle with beep every 10 seconds
- 2 Batteries included.

Charging Stand Light Indicators

LED color	Light Strength
Green	Normal
Orange	Light strength insufficient

Curing Status Light Indicators

LED color	Status Indication
Green	Normal
Red	Battery Voltage Low
Red Flashing	LED curing light handpiece is over temperature

Curing Mode Light Indicators

LED color	Working Mode
Green	Fast curing: Time setting 20 seconds (every 10 second, it sounds once)
Red	Pulse curing: interrupt radiating (every 10 seconds, it sounds once)
Orange	Step curing: soft start for 10 second from 0 to full power, then full power during the later 10 second



Charging Stand



ALED55N-1-G

ALED55N-1-R

ALED55N-1-B

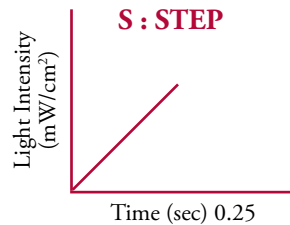
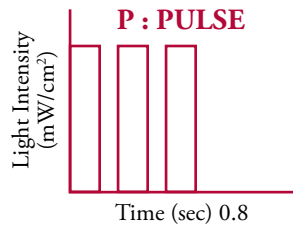
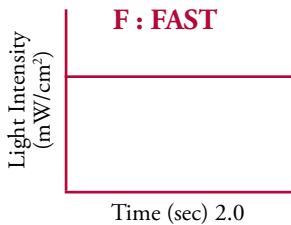

LM-300

Description

- LED 55N Cordless Curing Light Silver
- LED 55N Cordless Curing Light Blue
- LED 55N Cordless Curing Light Red

Model

- ALED55N-1-G Silver
- ALED55N-1-B Blue
- ALED55N-1-R Red

Suggested Retail Price

- \$500
- \$500
- \$500

Package includes the following:

- LED 55N cordless curing light ✓
- Charging stand with power indicator ✓
- Protective eye-shield ✓
- AC power supply ✓

Options:

		Retail
P109-LG	Replacement light guide for LED 55 (8mm)	\$82.00
ALED55N-BATT	Replacement battery	\$84.00
P208	Replacement protective eye-shield	\$10.50
P117	11mm light guide	\$110.00
LM300	Curing light meter	\$158.00

Shipping Dimensions: 10"L x 7"W x 4"H / 3 lbs.
(10/cs.) 21"L x 11"W x 14"H / 24 lbs.

LED 55BN

Built-in Curing Light System



Specifications

- Wavelength range: 430-490 nm
- Light Intensity: 1,250 mW / cm²
- Warranty: 2 year
- Power consumption: 5 W LED

Model ALED55-BN



LM-300



Curing Mode Light Indicators

LED color	Working Mode
Green	Fast curing: Time setting 20 seconds (every 10 second, it sounds once)
Red	Pulse curing: interrupt radiating (every 10 seconds, it sounds once)
Orange	Step curing: soft start for 10 second from 0 to full power, then full power during the later 10 second

Curing Status Light Indicators

LED color	Status Indication
Green	Normal
Red Flashing	LED curing light handpiece is over temperature

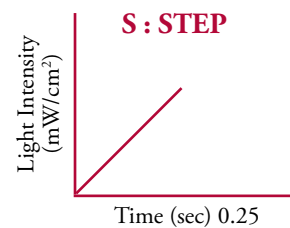
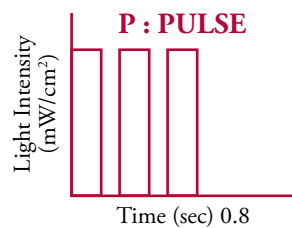
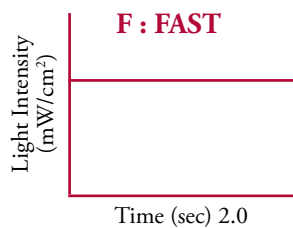

Description

Model

Suggested Retail Price

LED 55BN Built-in Curing Light (LED 5W installed in dental unit)	ALED55BN-A (110V - 240V)	\$410
LED 55BN Built-in Curing Light (LED 5W installed in dental unit)	ALED55BN-E (24V)	\$410

Package includes the following:

Turbo Light Guide	✓
Protective Eye-Shield	✓

Options:

		Retail
P109-LG	Replacement light guide for LED 55B	\$82.00
P208	Replacement protective eye-shield	\$10.50
LED 55BN-PS110	Replacement power supply 110V - 240V	\$60.00
LED 55BN-PS24	Replacement power supply 24V	\$60.00
P117	11mm light guide	\$110.00
LM300	Curing light meter	\$158.00

Shipping Dimensions: 10"L x 6"W x 2"H / 2 lbs.
(20/cs.) 21"L x 11"W x 12"H / 27 lbs.



LED 50N

Cordless Curing Light System

Specifications and Accessories

Switching Power Adapter

Power supply: AC 100-240V / 50-60 Hz
 Dimensions: 10"L x 2"W x 8"H

Hand Piece

Light source: 5W light emitting diode
 Wavelength: 430-490 nm
 Light Intensity: 800 - 1000 mW/cm²
 Battery: Lithium ion

Standard Accessories

- LED 50N handpiece
- charging base
- 8mm light guide
- Eye protector
- Lithium ion battery
- Power supply
- User's manual



LM-300



ALED-50N

Features

- Low battery signal – visual and audible alarm
- Easy to read – LCD display
- High light intensity – 5 to 10 second cure
- Flexibility – Cordless light cure
- Sleep mode – conserves power, saves battery life

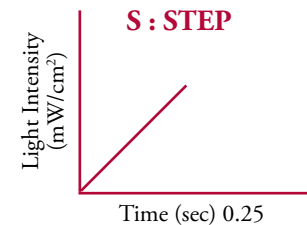
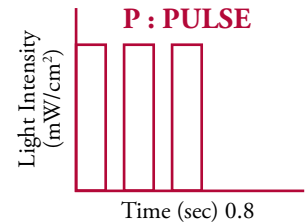
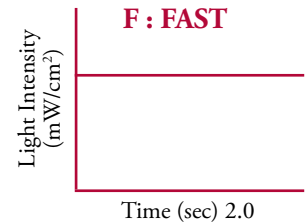

Description

LED 50 Cordless Curing Light

Package includes the following:

- LED 50 cordless curing light
- Charging base
- Protective eye-shield
- Counter top stand with power indicator
- 8mm light guide
- Built-in power transformer
- AC power supply

Model

ALED-50N

Suggested Retail Price

\$410

- ✓
- ✓
- ✓
- ✓
- ✓
- ✓
- ✓

Options:

- P109-LG Replacement light guide (8mm)
- P208 Replacement protective eye-shield
- LED 50-BATT Replacement rechargeable battery for LED 50
- P117 11mm light guide
- LM300 Curing light meter

Retail

- \$82.00
- \$10.50
- \$66.00
- \$110.00
- \$158.00

Shipping Dimensions: 10"L x 8"W x 5"H / 2 lbs.
 (10/cs.) 24"L x 10"W x 16"H / 20 lbs.

LED 39N

Curing Light System



Specifications

- Class: Class II (ICE601-1)
- Wavelength range: 430-490 nm
- Light Intensity: 1,000 mW / cm²
- Warranty: 2 year

Standard Accessories

- LED 39 handpiece
- Stand
- 8mm light guide
- Eye protector
- Power supply
- User Manual



Built-in
24 V Direct LED39BN

ALED-39N



ALED-39N

Curing Mode Light Indicators

LED color	Working Mode
Green	Fast curing: Time setting 20 seconds (every 10 second, it sounds once)
Red	Pulse curing: interrupt radiating (every 10 seconds, it sounds once)
Orange	Step curing: soft start for 10 second from 0 to full power, then full power during the later 10 second

Curing Status Light Indicators

LED color	Status Indication
Green	Normal
Red Flashing	LED curing light handpiece is over temperature

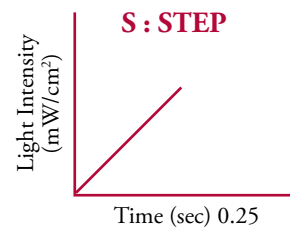
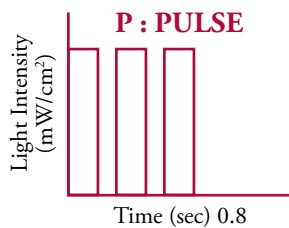
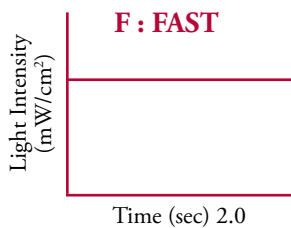

Description

LED 39N Curing Light
LED 39BN Curing Light

Model

ALED 39N
ALED 39BN (24V)

Suggested Retail Price

\$378
\$378

Package includes the following:

LED 39 curing light	✓
8mm light guide	✓
Protective eye-shield	✓
Stand	✓
Built-in power transformer	✓

Options:

P109-LG	Replacement light guide for LED 39N	\$82.00
P208	Replacement protective eye-shield	\$10.50
ALED 39N-PS	Replacement power supply	\$42.00

Shipping Dimensions: 13"L x 7"W x 3"H / 2 lbs.
(20/cs.) 24"L x 14"W x 14"H / 30 lbs.

Power Light 100

Halogen Curing Light





PL-100

Specifications

- Output light intensity: 500-600 mW/cm²
- Output wavelength range: 400-500 nm
- Preset curing times from 10 to 60 seconds or continuous cure
- LCD digital display
- Maintains constant light output and curing strength
- 8 mm light guide, protective eye shield and instruction manual included
- Powerful 75 Watt bulb
- Ultra quiet fan
- 1 year warranty (bulb excluded)

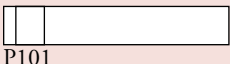
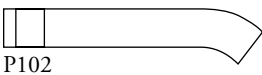
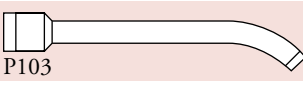
Lighting Guides

	13mm straight for large facial surface
	13mm x 80° for posterior occlusal curing
	8mm x 60° for general curing
	8mm - 3mm x 80° for layer curing of posterior restoration

Description

Power Light 100 Halogen Curing Light

Model

PL-100

Suggested Retail Price

\$490

Package includes the following:

Power Light 100 curing light	✓
8mm x 60° curing tip	✓
Protective eye-shield	✓
1 Year warranty	✓

Options:

		Retail
P101	13mm straight curing tip for large facial surface	\$110.00
P102	13mm x 80 degree curing tip for posterior occlusal curing	\$110.00
P103	8mm x 60 degree curing tip for general curing	\$82.00
P106	3mm x 90 degree curing tip for layer curing of posterior restoration	\$110.00
P201	Replacement bulb, 12V, 75W	\$39.00
P203	Protective eye shield for Power Light 100	\$17.90
L0005	Blue light filter + heat absorber (set).	\$98.00

Shipping Dimensions: 12"L x 9"W x 6"H / 6 lbs.
(4/cs.) 18"L x 13"W x 12"H / 26 lbs.



LM300

Curing Light Meter



LM-300



Description

LED Light Meter

Model

LM-300

Suggested Retail Price

\$158

Package includes the following:

LED Light Meter



Battery



1 Year warranty



Shipping Dimensions: 8"L x 4"W x 2"H / 1 lbs.

Advance 850LED

LED Piezo Scaler w/Bottle System



A850-LED

Standard Scaler Features

- Compact unit housing for easy placement anywhere in the operatory
- Extremely gentle on patient, causes little or no sensitivity
- No heat build up in handpiece tip with extended use
- Autoclavable handpiece
- Extensive power range to allow widest choice of clinical applications includes General, Perio and Endo
- Fine water spray eliminates excessive overspray onto patient
- Bottle water or External water source
- 6 tips included with unit
- Endodontic file holder & files included
- Easy and rapid operating for root canal treatment
- Achieve enlargement of canal quickly
- 1 year warranty

Technical Data

- Absorbed Power: Max 15W
- Scaler: Max 10W, 24 -28kHz, automatic tuning
- Water Pressure: 30 - 145 PSI
- Water Consumption: 10 - 50 cc/min
- Approvals: ETL, according to UL - 2601 - 1
- Classification according to Medical Device
- Directive 93/42 EEC: Class 11a

Included tips

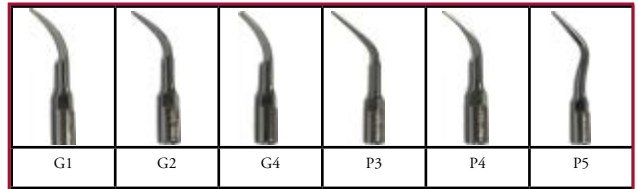

Description

Advance 850-LED Piezo Ultrasonic Scaler & Endodontic Unit

Model

A850-LED

Suggested Retail Price

\$870

Package includes the following:

Advance 850-LED piezo ultrasonic scaler with handpiece
 G1, G2, G4, P3, P4, P5 tips
 Foot control
 Tip wrench
 Water Bottle
 Endo file holder + files

Indicate EMS or Satellec style tips at time of order

- ✓
- ✓
- ✓
- ✓
- ✓
- ✓

Options

		Retail
A760	Endo files and holder (21mm #25)	\$72.00
A761	Piezo scaler tip #G1	\$30.00
A762	Piezo scaler tip #G2	\$30.00
A763	Piezo scaler tip #P3 Slim	\$30.00
A767	Piezo scaler tip #G4	\$30.00
A764	Piezo scaler tip #P4	\$30.00
A766	Piezo scaler tip #P5	\$30.00

Replacement Parts

		Retail
A746	Piezo scaler handpiece w/ LED	\$280.00
A776	Tip wrench	\$23.00
A749	Piezo scaler O-rings (5 pack)	\$9.00
A778	Replacement water line 7.5' w/ Q.C.	\$28.00
A775	Replacement scaler foot control	\$60.00
A850-RP-BTL	Replacement water bottle	\$25.00
A781	Replacement LED HP tubing	\$114.00
A746-RP101	Replacement LED light	\$50.00

Shipping Dimensions: 18"L x 14"W x 5"H / 6 lbs.
 (4/cs.) 18"L x 15"W x 21"H / 26 lbs.

Advance 750LED

LED Piezo Scaler



A750LED

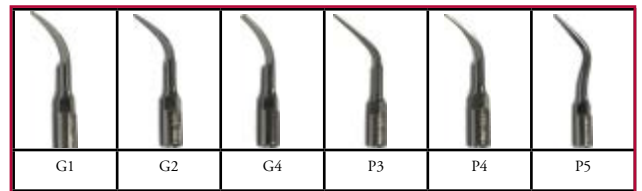

Included tips

Standard Scaler Features

- Compact unit housing for easy placement anywhere in the operatory
- intense LED Light Source
- Extremely gentle on patient, causes little or no sensitivity
- No heat build up in handpiece tip with extended use
- Autoclavable handpiece
- Extensive power range to allow widest choice of clinical applications
- Fine water spray eliminates excessive overspray onto patient
- Thin subgingival tips available
- 6 tips included with unit

Optional Endodontics Unit Features

- Endodontic file holder
- Easy and rapid operating for root canal treatment
- Achieve enlargement of canal quickly

Specifications

- Input rating: 115/230V, 50/60 Hz
- Dimensions: 160mm(W) x 155mm(D) x 70mm(H)
- Weight: 2.1 kg
- Frequency: 32 KHz
- Water pressure: 1-4 kg/cm²
- Fuses: 230V, 2 per unit ; F0.5A 250V-CQ-S500
- Fuses: 110V, 1 per unit ; F1A 5A 250V-CQ-S500
- 6 tips included with unit
- 1 year warranty (tips excluded)

Description

Advance 750N Piezo Ultrasonic Scaler & Endodontic Unit
 Advance 750N Piezo Ultrasonic Scaler & Endodontic Unit W/LED

Model

A750N
 A750LED

Suggested Retail Price

\$598
 \$690

Package includes the following:

Advance 850-LED piezo ultrasonic scaler with handpiece
 G1, G2, G4, P3, P4, P5 tips
 Foot control
 Tip wrench
 Water bottle
 Endo file holder + files

Indicate EMS or Sateltec style tips at time of order

- ✓
- ✓
- ✓
- ✓
- ✓
- ✓

Options

Options	Retail
A760 Endo files and holder (21mm #25)	\$72.00
A761 Piezo scaler tip #G1	\$30.00
A762 Piezo scaler tip #G2	\$30.00
A763 Piezo scaler tip #P3 Slim	\$30.00
A767 Piezo scaler tip #G4	\$30.00
A764 Piezo scaler tip #P4	\$30.00
A766 Piezo scaler tip #P5	\$30.00

Replacement Parts

Replacement Parts	Retail
A746 Piezo scaler handpiece w/ LED	\$280.00
A776 Tip wrench	\$23.00
A749 Piezo scaler O-rings (5 pack)	\$9.00
A778 Replacement water line 7.5' w/ Q.C.	\$28.00
A775 Replacement scaler foot control	\$60.00
A745 Replacement Scaler HP Non LED	\$198.00
A781 Replacement HP tubing W LED source	\$114.00
A780 Replacement HP tubing Non LED	\$94.00
A746-RP101 Replacement LED light	\$50.00

Shipping Dimensions: 13"L x 10"W x 5"H / 5 lbs.
 (8/cs.) 21"L x 14"W x 18"H / 42 lbs.

Advance 800N

Piezo Ultrasonic Built-In Scaler



A800N

A800LED



Features

- Extremely gentle on patient, causes little or no sensitivity
- No heat build up in handpiece tip with extended use
- Autoclavable handpiece
- Extensive power range to allow widest choice of clinical application
- Fine water spray eliminates excessive overspray onto patient
- Thin subgingival tips available
- 6 tips included with unit
- 1 year warranty (tips excluded)

Additional Benefits

- The Advance 800N eliminates the need for external water line and power cord connections
- The Advance 800N operates from unit foot control - no additional foot control needed
- The Advance 800N allows for a clean appearing operatory eliminating all visible tubes and power lines.

Specifications

- Transformer: 24V, 1 amp
- Activated by unit foot control – no additional foot control needed
- Small electronic box, 2-3/8"L x 1.5"W x 1.25"H
- Easy tip system allows tips to be changed easily
- Absorbed power: max 15 watt
- Scaler: max 10 watt, 24-28 kHz, automatic tuning
- Water pressure: 30-145 PSI
- Water consumption: 10-50 cc/min
- No external water line / power cord
- 1 year warranty (tips excluded)
- Indicate EMS or Satellec Tips on all orders

Description	Model	Suggested Retail Price
Advance 800N Piezo Ultrasonic Built In Scaler	A800N	\$530
Advance 800N Piezo Ultrasonic Built In Scaler W/LED	A800LED	\$610
Package includes the following:	Indicate EMS or Satellec style tips at time of order	
Advance 800N piezo ultrasonic scaler with handpiece	✓	
#G1, #G2, #G4, #P3, #P4, #P5 tip	✓	✓
Tip wrench	✓	✓
Transformer	✓	✓
Control box	✓	✓
Advance 800 LED handpiece		✓

Options	Retail	Replacement Parts	Retail
A760 Endo files and holder (21mm #25)	\$72.00	A746 Piezo scaler handpiece w/ LED	\$280.00
A761 Piezo scaler tip #G1	\$30.00	A776 Tip wrench	\$23.00
A762 Piezo scaler tip #G2	\$30.00	A749 Piezo scaler O-rings (5 pack)	\$9.00
A763 Piezo scaler tip #P3 Slim	\$30.00		
A767 Piezo scaler tip #G4	\$30.00	A745 Replacement Scaler HP non LED	\$198.00
A764 Piezo scaler tip #P4	\$30.00	A782 Replacement HP tubing W LED source	\$114.00
A766 Piezo scaler tip #P5	\$30.00	A780 Replacement HP tubing non LED	\$94.00
		A746-RP101 Replacement LED light	\$50.00
		A800N-PCB Main PCB	\$157.50
		A800N-WH-HARNESS	\$22.00

Shipping Dimensions: 9"L x 7"W x 4"H / 4 lbs.
(10/cs.) 14"L x 10"W x 18"H / 40 lbs.



PowerMAX25

Ultrasonic Scaling System



Features

- Available in 25Khz
- Precision automatic tuning circuitry
- Linear power control for exact power setting
- Accepts Cavitron®, P, SLI, TFI, and FSI scaler inserts
- Compact and lightweight
- Auto-ranging 110-240 VAC input
- Includes one ultrasonic scaler insert and foot control
- 1 year warranty

Specifications

Weight: 6 lbs
 Dimensions: 8"(W) x 8"(D) x 3"(H)
 Output power to tip: Operatory adjust approximately 10-40 watts
 Handpiece cable: 6'
 Power supply to unit: 110-240 VAC Input, 50/60 Hz
 Water flow and supply pressure: 18 cc to 30 cc per minute flow from insert tip
 Supply pressure to scaler is 25-60 PSIG city water or bottle system

Description	Model	Suggested Retail Price
PowerMAX25 Ultrasonic Scaler with insert	PM25	\$720

Package includes the following:

PowerMAX ultrasonic scaler	✓
25K universal scaler insert	✓
Foot control	✓
1 year warranty	✓

Options:

		Retail
S1025	25K universal insert-external water flow	\$74.00
S1030	30K universal insert- external water flow	\$74.00
S2025	25K universal slim insert- external water flow	\$74.00
S2030	30K universal slim insert- external water flow	\$74.00
S3025	25K universal insert- plastic handle- internal water flow	\$74.00
S3030	30K universal insert- plastic handle- internal water flow	\$74.00
S4025	25K universal slim insert- plastic handle- internal water flow	\$74.00
S4030	30K universal slim insert- plastic handle- internal water flow	\$74.00
S8001	25K Replacement handpiece w/ Tubing	\$110.00
PM775	Power Max replacement foot control	\$82.00
A778	Replacement water line 6' long with male quick disconnect (with shut off)	\$28.00

Shipping Dimensions: 12"L x 12"W x 4"H / 8 lbs.
 (5/cs.) 18"L x 13"W x 14"H / 38 lbs.

Ultrasonic Scaler Inserts



#S1025
25K Universal Scaler Insert
(metal handle)

#S1030
30K Universal Scaler Insert
(metal handle)

Features

- External water
- Interchangeable for use with other brands of scalers
- 90 day warranty against defects arising from faulty materials or workmanship



#S2025
25K Universal Slim Scaler Insert
(metal handle)

#S2030
30K Universal Slim Scaler Insert
(metal handle)

Features

- Slim tip design
- External water
- Interchangeable for use with other brands of scalers
- 90 day warranty against defects arising from faulty materials or workmanship



#S3025
25K Universal Scaler Insert
(black plastic handle)

#S3030
30K Universal Scaler Insert
(black plastic handle)

Features

- Internal water delivery system delivers water directly to the insert tip and focuses it where it is needed most
- Large, round, non-slip plastic grip for greater tactile sensitivity, rotational control and reduced hand fatigue
- Better water management and less water usage means greater patient comfort
- Interchangeable for use with other brands of scalers
- 90 day warranty against defects arising from faulty materials or workmanship



#S4025
25K Universal Slim Scaler Insert
(blue plastic handle)

#S4030
30K Universal Slim Scaler Insert
(blue plastic handle)

Features

- Internal water delivery system delivers water directly to the insert tip and focuses it where it is needed most
- Large, round, non-slip plastic grip for greater tactile sensitivity, rotational control and reduced hand fatigue
- Better water management and less water usage means greater patient comfort
- Interchangeable for use with other brands of scalers
- 90 day warranty against defects arising from faulty materials or workmanship

Model	Description	Retail
S1025	25K universal insert-external water flow	\$74.00
S1030	30K universal insert- external water flow	\$74.00
S2025	25K universal slim insert- external water flow	\$74.00
S2030	30K universal slim insert- external water flow	\$74.00
S3025	25K universal insert- black plastic handle- internal water flow	\$74.00
S3030	30K universal insert- black plastic handle- internal water flow	\$74.00
S4025	25K universal slim insert- blue plastic handle- internal water flow	\$74.00
S4030	30K universal slim insert- blue plastic handle- internal water flow	\$74.00
S8003	Ultrasonic scaler insert O-rings (5 pack)	\$10.00

Shipping Dimensions: 9"L x 2"W x 1"H / 1 lbs.



AS 5000

Sonic Air Scaler



AS5000-M4

Features

- Includes 3 tips AS1, AS2, AS3.
- Tip wrench included.
- Light weight
- Portable
- Saves time
- Autoclaveable
- Available in 2 or 4 hole.

Description	Model	Suggested Retail Price
Air Sonic Scaler -4 Hole Kit	AS5000-M4	\$285
Air Sonic Scaler -2 Hole Kit	AS5000-B2	\$285

Package includes the following:

AS5000 Air sonic scaler handpiece	✓	✓
AS1 Universal Tip	✓	✓
AS2 Sickle Tip	✓	✓
AS3 Perio Tip	✓	✓
A776 Tip Wrench	✓	✓
6 Month warranty		

Options:

	Retail
AS1 Universal Tip	\$25.00
AS2 Sickle Tip	\$25.00
AS3 Perio Tip	\$25.00
A776 Scaler Tip Wrench Only	\$23.00

Shipping Dimensions: 9"L x 4"W x 2"H / 1 lbs.



Air Polishing System

Polishing System

EZ Nozzle

- Carefully designed length, angle and curve of nozzle for applications to both anterior and posterior teeth. Allows for accurate direction of the power jet
- Includes two prophyl nozzles
- Handpiece nozzle is fully autoclavable up to 134 °C / 273 °F

Ergo Comfort Design

- Fits comfortably in large and small hands. Notched grip allows firm and accurate tip control

Lightweight & Flexible

No Installation Cost

- Simply connects to handpiece tubing
- No extra foot control needed
- No external air or water connections needed

Cleaning Power

- Jet Polishing powder (130g) has a refreshing mint scent

Powder Holder Covers

- Three translucent color coded holder covers are included (blue, green, purple)

Quick Connection

- Simply pull back the quick release ring to release the nozzle from the handpiece



P560

Description	Model	Suggested Retail Price
Air Polishing System	P555-4H	\$250
Air Polishing System	P557-4H	\$290

Package includes the following:

1 – 130g of prophyl powder	✓	✓
3 – color coded (red, blue, green) powder holder covers	✓	✓
2 – nozzles (360 degree swivel)	✓	✓
1 – cleaning tool	✓	✓
1 – O-ring set	✓	✓
1 year warranty	✓	✓

Options:

	Retail
P560 130g of prophyl powder	\$14.90
P660 Nozzle for P555	\$52.00
P665 Nozzle for P557	\$63.00

Shipping Dimensions: 9"L x 8"W x 3"H / 2 lbs.
(10/cs.) 13"L x 13"W x 10"H / 12 lbs.



Ultrasonic Cleaner

Dentsonic UC 400 / 1000



Model UC-400

Features

- Powerful 40 KHz of cavitation for thorough, quieter cleaning
- Stainless steel cover and tank with welded drain
- Durable vinyl clad steel housing is scratch resistant and easy to clean
- Digital timer for quick and easy process
- Sweep technology ensures exceptional cleaning efficiency
- 1 year warranty
- 2 tank sizes available 3.8 qt / 10.6qt
- Includes basket and lid



Stainless Steel Cover



Stainless Steel Basket



Drain kit only available on UC1000

MODEL	UC-400	UC-1000
Input 115V	✗	✓
Input 230V	✓	✓
Frequeny	50/60 Hz	50/60 Hz
Overall Dimensions L x W x H	10.6" x 6.3" x 9.5" 27cm x 16cm x 24cm	14.2" x 10.6" x 12.2" 36cm x 27cm x 31cm
Tank Internal Dimensions L x W x H	9.5" x 5.5" x 4" 24cm x 14cm x 10cm	11.8" x 9.5" x 5.9" 30cm x 24cm x 15cm
Ship Weight	10 lbs. 4.5 Kg	19 lbs. 8.6 Kg
Tank Capacity	3.8 Qts. / .95 Gallon 3.59 Liter	10.6 Qts. / 2.65 Gallon 10 Liter
Timer	LCD Display 1-99 minutes	LCD Display 1-99 minutes
302 StainlessSteel	✓	✓

UC-400 14 "L x 13"W x 11"H / 11 lbs.

UC-1000 17 "L x 15"W x 16"H / 21 lbs.

Description

Model

Retail Price

UC-400 Ultrasonic Cleaner (3.8 qt.)
UC-1000 Ultrasonic Cleaner (10.6 qt)

UC-400

UC-1000

\$640

\$1,230

Package includes the following:

Ultrasonic cleaner	✓	✓
Stainless steel basket	✓	✓
Stainless steel lid	✓	✓
Drain kit		✓
Timer	✓	✓

Options

Retail Price

UC400-BASKET	Replacement Basket (3.8 qt.)	\$84.00
UC1000-BASKET	Replacement Basket (10.6 qt)	\$128.00

Dentsonic

Ultrasonic Cleaner



UC-250



Features

- Powerful 35 KHz of cavitation for thorough, quieter cleaning
- Stainless steel tank
- Durable plastic housing is scratch resistant and easy to clean
- Digital timer for quick and easy process
- Sweep technology ensures exceptional cleaning efficiency
- 2 tank sizes available 2.5qt., 3.0qt.
- Includes basket and lid
- 1 year warranty



UC-300



UC-600-GBS
Glass Beaker Set
500 ML x 2 and holder
Fits: UC300, 600, 750



UC-300-S

Shipping Dimensions

UC-250	14"L x 11"W x 10"H / 8 lbs. (4/cs) 23L x 15W x 20H / 35lbs.
UC-300	20"L x 14"W x 12"H / 16 lbs. (2/cs) 20"L x 14"W x 24"H / 34Lbs

Model	UC-250	UC-300
Input 115Vac	✓	✓
Input 220Vac	✓	✓
Frequency	50/60 Hz	50/60 Hz
Overall dimensions	12.6" x 9.6" x 8.0"	17.5" x 10.8" x 8.1"
Tank Internal Dimensions	9.8" x 6.0" x 3.0"	9.8" x 7.0" x 3.0"
Shipping Weight	8 lbs	13 lbs
Tank Capacity	2.5 qt, 0.65 Gal, 2.46 L	3.0 qt, 0.8 Gal, 3.028 L
Digital Timer	LCD Display 1-30 min	LCD Display 1-30 min
302 Stainless Steel Tank	✓	✓

Description

UC-250 Ultrasonic Cleaner 2.5 Qt UC-250

UC-300 Ultrasonic Cleaner 3.0 Qt (W/ Stainless Steel Basket) UC-300-S

Model

Suggested Retail Price

\$278

\$430

Options

UC-600-GBS Glass Beaker Set (500ML X 2 and holder) Fits UC 300, UC600, UC 750

Model

\$70.00

Package includes the following:

Ultrasonic cleaner	✓	✓
Basket	✓	✓
Lid	✓	✓
Drain kit	✓	✓
Digital timer	✓	✓
Heater	✓	✓

Dentsonic

Ultrasonic Cleaner



Features

- Powerful 35 KHz of cavitation for thorough, quieter cleaning
- Stainless steel tank
- Durable plastic housing is scratch resistant and easy to clean
- Digital timer for quick and easy process
- Sweep technology ensures exceptional cleaning efficiency
- 2 tank sizes available
 - 1.6 Gallon
 - 2.0 Gallon
- Includes basket and lid
- 1 year warranty



UC-600



Shipping Dimensions

UC-600	23 "L x 16"W x 14 "H / 23 lbs.
UC-750	24 "L x 16"W x 14"H / 27lbs.



UC-600-S



UC-750

Model	UC-600	UC-750
Input 115Vac	✓	✓
Input 220Vac	✓	✓
Frequency	50/60 Hz	50/60 Hz
Overall dimensions	21.0" x 12.0" x 9.6"	21.3" x 13.3" x 10.9"
Tank Internal Dimensions	13" x 8.0" x 4.0"	13" x 9.4" x 4.1"
Shipping Weight	20 lbs	25 lbs
Tank Capacity	6.4 qt, 1.6 Gal, 6.056 L	8 qt, 2 Gal, 7.5 L
Digital Timer	LCD Display 1-30 min	LCD Display 1-30 min
302 Stainless Steel Tank	✓	✓

Description

UC-600 Ultrasonic Cleaner 1.6 Gallon Plastic Basket
 UC-600 Ultrasonic Cleaner 1.6 Gallon Stainless Steel Basket
 UC-750 Ultrasonic Cleaner 2.0 Gallon Stainless Steel Basket

UC-600
 UC-600-S
 UC-750

Model

Suggested Retail Price

\$720
\$750
\$998

Package includes the following:

Ultrasonic cleaner	✓	✓
Basket	✓	✓
lid	✓	✓
Drain kit	✓	✓
Digital timer	✓	✓
Heater	✓	✓

Options

UC600-BSKT-P
 UC600-BSKT-SS
 UC750-BSKT-SS

Replacement Plastic Basket
 Replacement Stainless Steel Basket (70cm)
 Replacement Stainless Steel Basket (70cm)

Suggested Retail Price

\$22.00
 \$92.00
 \$106.00

TPC Dentsonic Ultrasonic Cleaner

Cassette Cross reference

851 South Lawson Street City of Industry CA 91748 • tpcdental.com • 800-560-8222

	UC-250	UC-300	UC-400	UC-600	UC-750	UC-1000
Tank Size (L x W x H)	9.6" x 5.9" x 3.0"	9.8" x 6.9" x 3.1"	9.5" x 5.5" x 4"	12.7" x 8.1" x 3.9"	12.5" x 9" x 3.5"	11.8" x 9.5" x 5.9"
Hu-Friedy						
Large Cassette 16-Instruments 8" x 11" x 1.25"				✓	✓	✓
Large Cassette 20-Instruments 4.5" x 8" x 1"			✓	✓	✓	✓
Small Cassette 8-Instruments 5.5" x 8" x 1.25"	✓	✓	✓	✓	✓	✓
Small Cassette 10-Instruments 5.5" x 8" x 1.25"	✓	✓	✓	✓	✓	✓
Exam Cassette 5-Instrument 3" x 8" x 1.25"	✓	✓	✓	✓	✓	✓
Space Saver 7-Instrument 4.5" x 8" x 1"	✓	✓	✓	✓	✓	✓
Double Decker Cassette 8-Inst. 3" x 8" x 1.5"	✓	✓	✓	✓	✓	✓
Double Decker Cassette 14-Inst. 4.5" x 8" x 1.5"	✓	✓	✓	✓	✓	✓
Double Decker Cassette 20-Inst. 6" x 9.7" x 1.5"		✓	✓	✓	✓	✓
Sigma Stat Cassette 12-Inst. 6.5" x 10.5" x 1.25"				✓	✓	✓
Oral Surgery Cassette 12-Inst. 8" x 14.5" x 1.25"						
Radiography Cassette 4.5" x 8" x 1.5"		✓	✓	✓	✓	✓
Handpiece Cassette 3" x 8" x 1.25"	✓	✓	✓	✓	✓	✓
Ultrasonic Insert Cassette 1.5" x 8" x 1.25"	✓	✓	✓	✓	✓	✓
Zirc						
E-Z Jet Cassette 10-Place 7.93" x 7" x 1.125"				✓	✓	✓
E-Z Jet Cassette 8-Place 7.93" x 4.4375" x 1.125"	✓	✓	✓	✓	✓	✓
E-Z Jet Cassette 5-Place 8" x 3.125" x 1.1875"		✓	✓	✓	✓	✓
Compact Cassette 7.125" x 3.875" x 0.625"		✓	✓	✓	✓	✓
Mini Mat 3.875" x 3.5" x .5"	✓	✓	✓	✓	✓	✓
Instrument Mat 6.75" x 2" x 0.375"	✓	✓	✓	✓	✓	✓
Standard Steri-Container 8.125" x 1.875" x 1.875"	✓	✓	✓	✓	✓	✓
Compact Steri-Container 7.125" x 1.5" x 1.5"	✓	✓	✓	✓	✓	✓

Warning: There should absolutely be NO metal-metal contact inside of the tank during ultrasonic cycle

This includes No direct: Loose Instrument-to-Instrument, Cassette-to-Tank, Cassette-to-Cassette, Cassette-to-Basket; metal contact. Make sure Cassettes have standard silicone insulations and feet; if no basket is used.

Tank Dimensions are measured without baskets; basket sizes vary depending on unit.

Please contact your cassette manufacturer or TPC if you have any questions.

D650N

Digital Amalgamator



D-650N

Features

- ISO 9002 / ISO 13488 quality management certified
- Input voltage: 110V or 230V
- Touch pad selector
- Pre-programmed time settings
- Quiet, high-speed mix capsules
- Built-in automatic timer
- Accepts all capsules
- Customized trituration times
- Vibration frequency \geq 4,400 RPMs
- 1 year warranty

Description

D650N Digital Amalgamator

Model

D-650N

Suggested Retail Price

\$420

Package includes the following:

D650N digital amalgamator

✓

AC power cord

✓

Shipping Dimensions: 13"L x 10"W x 10"H / 10 lbs.
(2/cs.) 20"L x 14"W x 10"H / 20 lbs.



N7

Micromotor and Handpiece



Features

- Powerful torque and variable speed motor
- No heat after long hours of operation
- Easy change of driving direction for efficiency
- Variable speed foot control
- Compact and ergonomic design
- Automatic stop with alarm beep and overload reset
- Includes control unit, motor handpiece and foot pedal
- 0–35,000 RPMs
- 110/220V ; 50/60Hz, 0.7A
- 1 year warranty

Description	Model	Suggested Retail Price
TPC Marathon N7 Micromotor and Handpiece	MM7	\$598
TPC Marathon N2 Micromotor and Handpiece	MM2	\$398

Package includes the following:

N7 micromotor and handpiece	✓
AC power cord	✓
Foot pedal	✓

Options:

		Retail
MM7-HP	Handpiece only with cable	\$358.00
MM7-MOTOR	Motor control box	\$358.00
MM7-VFC	Replacement foot control	\$69.00
MM7-BR	Replacement carbon brushes	\$15.00

Shipping Dimensions: 11"L x 11"W x 5"H / 7 lbs.
(8/cs.) 24"L x 12"W x 21"H / 58 lbs.



Digital Thermometer

Non-Contact Digital-Infrared



1s Measurement



Forehead Mode



Fever Warning



LED Display



One-click
Operation



Features

- Non-contact design
- Hygienic & professional
- Comfortable to hold
- Fever warning
- Multiple measurement modes
- 1 year warranty

Description

Thermometer, Non-Contact Digital Infrared

Model

PPE-DT

Suggested Retail Price

\$53.00

Shipping Dimensions:



Face Shields

Disposable Face Shields



Features

- Anti-fog treatment on both sides of shield
- Covers: face, sides of face, chin & below chin
- Disposable

Item# PPE-FS

Description: Splash Protection Face Shield

*** 24 Shields / Box**

Description

Disposable Face Shields, box of 24 pcs
Disposable Face Shields, box of 100 pcs
Disposable Face Shields, case of 240 pcs

Model

#PPE-FS
#PPE-FS-100
#PPE-FS (10)

Suggested Retail Price

\$29.00
\$114.00
\$267.00

Shipping Dimensions:



Isolation Gowns

Disposable - Knit Cuff - Latex Free



Features

- Knit cuff, Latex free, fluid resistant
- Non-woven material
- One size fit for most people
- Extra coverage with back and neck tie
- Provides Level 3 barrier protection
- Weight 45 G
- Size 49.2" (long), 27.6" (Wide), 23.62" (sleeve)
- Standard GB/T 38462-2020
- Color BLUE
- 50 pcs/box
- production date May 02 , 2020

*** 50 Gowns / Box**

Description

Isolation Gown, Disposable case of 50

Model

#PPE-IGKB

Suggested Retail Price

\$240.00

Shipping Dimensions:



Surgical Ear-Loop Level

Face Mask



Features

- Disposable
- 3-ply
- Splash resistant

*** 50 mask / Box**

Meets EN14683 Rating

Type IIR Standard

Meets ASTM Level 2

Standard

Description

Surgical Ear Loop Level II Face Mask, case of 1,000

Model

#PPE-PEMBL (Blue)

Suggested Retail Price

Call for price

Shipping Dimensions:

Surgical Ear-Loop Level IIR

Face Mask



1 Featured non-woven fabrics
2 Meltblown cloth protective layer
3 Hygroscopic non-woven fabric



Features

- Disposable
- 3-ply
- Splash resistant

* 50 mask / Box

* 20 boxes = 1 Case

Meets EN14683 Rating

Type IIR Standard

Meets ASTM Level 2

Standard

Description

Surgical Ear Loop Level IIR Face Mask, box of 50
Surgical Ear Loop Level IIR Face Mask, box of 50

Model

#PPE-PEMPK-2 (Pink)
#PPE-PEMBL-2 (Blue)

Suggested Retail Price

\$159.00
\$159.00

* Minimum order 1 case

Shipping Dimensions:

Disposable Micro Applicators



M6500-XSL
(Black)



• Four individual dispenser tubes included with each box

• 36 Boxes/case

Part No.	Description	Retail	1 Case	3+ Case
M6500-R	Disposable Micro Applicators, 400 ct. (Green / Orange)	\$17.50/Box	\$12.00/Box	\$10.00/Box
M6500-F	Disposable Micro Applicators, 400 ct. (Yellow / Blue)	\$17.50/Box	\$12.00/Box	\$10.00/Box
M6500-SF	Disposable Micro Applicators, 400 ct. (White / Purple)	\$17.50/Box	\$12.00/Box	\$10.00/Box
M6500-XSL	Disposable Micro Applicators, 400 ct. (Black)	\$17.50/Box	\$12.00/Box	\$10.00/Box

Package includes the following:

Four dispenser tubes, 100 brushes per tube

Features

- Non- linting fibers
- Bendable stiff tip
- Dispensing tubes eliminate the potential for cross contamination.

Shipping Dimensions: 4"L x 4"W x 5"H / 1 lbs.
(36/cs.) 17"L x 13"W x 15"H / 35 lbs.



Disposable Syringe Tips

Description

P7700 Disposable White Syringe Tip
P7700-Bulk-refill (1600 pcs) Does not include dispenser

- Metal Interior
- 250 tips / box
- Syringe tip dispensers included (125 tips per dispenser)
- 36 boxes per case



Retail

\$40.00/ box
\$192.00

1 Case

\$30.00/box

3+ Case

\$24.00/ box

Features

- No adapter required fits most syringes (Unless converting from proprietary tip adapter)
- Interchangeable with metal syringe tip
- Available in a variety of bright colors
- Dispensing container reduces the risk of cross contamination

Shipping Dimensions:	6"L x 3"W x 4"H / 2 lbs.
	36/cs 18"L x 13"W x 14"H / 48 lbs.
Bulk refill	40/cs 18"L x 10"W x 9"H / 33 lbs.

Description

P7705 Disposable White Syringe Tip
P7705-Bulk-refill (1600 pcs) Does not include dispenser

- Plastic Interior
- 250 tips / box
- Syringe tip dispensers included (125 tips per dispenser)
- 36 boxes per case



Retail

\$30.00/ box
\$140.00

1 Case

\$22.00/box

3+ Case

\$16.00/ box

Features

- No adapter required fits most syringes (Unless converting from proprietary tip adapter)
- Interchangeable with metal syringe tip
- Available in a variety of bright colors
- Dispensing container reduces the risk of cross contamination

Shipping Dimensions:	6"L x 3"W x 4"H / 1 lbs.
	36/cs 18"L x 13"W x 14"H / 32 lbs.
Bulk refill	40/cs 18"L x 10"W x 9"H / 18 lbs.

Description

P7725 Rainbow Syringe Tip (Rainbow interior)
P7725-Bulk-refill (1600 pcs) Does not include dispenser

- Rainbow colored interior tip
- 250 tips / box
- 2 Syringe tip dispensers included (125 tips per dispenser)
- 36 boxes per case



Retail

\$30.00/ box
\$140.00

1 Case

\$22.00/box

3+ Case

\$16.00/ box

P7720 Rainbow Syringe Tip (Rainbow exterior)
Use P7725 pricing



Features

- No adapter required fits most syringes (Unless converting from proprietary tip adapter)
- Interchangeable with metal syringe tip
- Available in a variety of bright colors
- Dispensing container reduces the risk of cross contamination

Disposable Prophylaxis Angles



(Pink Color / Soft Cup)



(Teal Color / Regular Cup)

- Latex free
- Individually packaged

- 20 Boxes/case PA-N-144
- 8 Boxes/case PA-N-500

Shipping Dimensions, Qty. **500:** 13"L x 11"W x 8"H / 4 lbs.
(8/cs.) 22"L x 14"W x 32"H / 36 lbs.

Shipping Dimensions, Qty. **144:** 10"L x 7"W x 6"H / 1 lbs.
(20/cs.) 20"L x 14"W x 29"H / 29 lbs.

Part No.	Description	Retail	1 Case	3+ Case
PA-N-144-R	Disposable prophylaxis angles, 144 ct., Regular	\$50.00/Box	\$45.00/Box	\$43.00/Box
PA-N-500-R	Disposable prophylaxis angles, 500 ct., Regular	\$160.00/Box	\$150.00/Box	\$144.00/Box
PA-N-144-S	Disposable prophylaxis angles, 144 ct., Soft	\$50.00/Box	\$45.00/Box	\$43.00/Box
PA-N-500-S	Disposable prophylaxis angles, 500 ct., Soft	\$160.00/Box	\$150.00/Box	\$144.00/Box

Disposable Evacuator Tips



SAT-SW
Small (25 tips / bag) White

Shipping Dimensions: 11"L x 7"W x 9"H / 5 lbs.
(160/cs)23"L x 15"W x 18"H / 37 lbs.



SAT-LG
Large (25 tips / Bag) Green

Shipping Dimensions: 11"L x 7"W x 9"H / 6 lbs.
(160/cs)23"L x 15"W x 18"H / 46 lbs.

Part No.	Description	1 Box (20 Bags)	8 Box (160 Bags)
SAT-SW	Small Surgical Aspirator Tip (1/8") White	\$66.00	\$60.00
SAT-LG	Large Surgical Aspirator Tip (1/4") Green	\$66.00	\$60.00

Minimum Order 1 box



HVE-1000
(100 tips / bag) x 10 Bags

Shipping Dimensions: 12"L x 10"W x 10"H / 8 lbs.
(40 bag/cs)20"L x 13"W x 21"H / 32 lbs.

Part No.	Description	1 box
HVE-1000	High Volume Combo Tip (10 bags / box)	\$38.00/box

Lab Products



2" Crown Box



1" Crown Box



Honey Comb Tray
W/ Metal Pin



Honey Comb Tray
W/ Ceramic Pin



Dowl Pin



Disposable Articulators
Black



Disposable Articulators
White

Part No.	Description	Retail
LAB-CRWBX-2	Plastic Crown Box W/ 2" Foam 500 / cs (Blue)	\$148.00
LAB-CRWBX-2BLK	Plastic Crown Box W/ 2" Foam 500 / cs (Black)	\$148.00
LAB-CRWBX-1	Plastic Crown Box W/ 1" Foam 1000 / cs (Blue)	\$182.50
LAB-CRWBX-1BLK	Plastic Crown Box W/ 1" Foam 1000 / cs (Black)	\$182.50
LAB-HC-CP	Honey Comb Tray W/ Ceramic Pin	\$13.50
LAB-DP-M	Medium Dowl Pin 1000 / Bx	\$29.00
LAB-DART-WH	Disposable Articulators White 100 / Bag	\$17.50
LAB-DART-BLK	Disposable Articulators Black 100 / Bag	\$15.50

Disposable Prophy Cups & Brushes



Description			Model	Retail
Latch type prophy brush	flat / white	pkg of 144	PB-300	\$38.00
Latch type prophy brush	flat / black	pkg of 144	PB-310	\$40.00
Screw-on type prophy brush	flat / white	pkg of 144	PB-320	\$36.00
Screw-on type prophy brush	pointed / white	pkg of 144	PB-330	\$36.00
Latch type prophy brush	pointed / white	pkg of 144	PB-340	\$38.00
Latch type prophy brush	pointed / black	pkg of 144	PB-350	\$40.00
Latch type prophy brush	cup shade / white	pkg of 100	PB-360	\$38.00
Latch type prophy brush	cup shade / bristle	pkg of 100	PB-370	\$42.00
Latch type prophy cup	webbed / white	pkg of 144	PC-505	\$22.00
Screw-on type prophy cup	webbed / white	pkg of 144	PC-515	\$25.00
Pointed-on prophy cup	webbed / white	pkg of 144	PC-525	\$25.00
Snap-on prophy cup	webbed / white	pkg of 144	PC-535	\$13.00

Shipping Dimensions: 4"L x 3"W x 2"H 1lbs.

* 9 + 1 Free



Alligator X-ray Film Holder - Straight

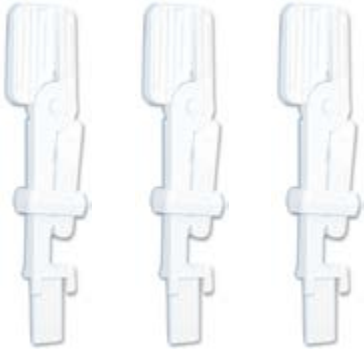

Part No.	Description	Retail
M7000-S	Alligator film holder (straight)	\$13.00

- Straight
- Box of 3

Post Mount Utility Tray

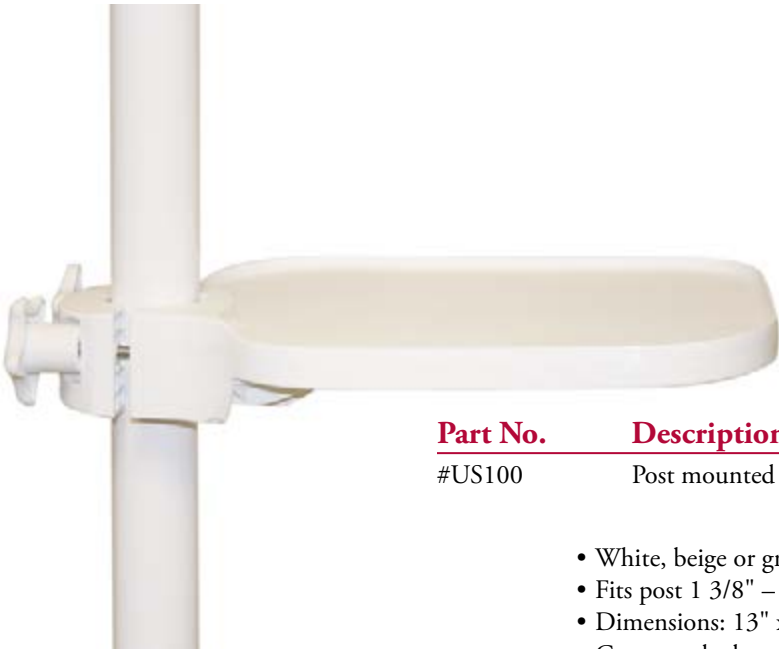

Part No.	Description	Retail	1 Case
#US100	Post mounted utility tray (specify color)	\$60.00	\$50.00

- White, beige or grey
- Fits post 1 3/8" – 2 1/2"
- Dimensions: 13" x 10"
- Contoured edge to contain spills and materials

• 20 Trays/Case

Shipping Dimensions: 17"L x 10"W x 3"H / 2 lbs.
(20/cs.) 25"L x 22"W x 18"H / 38 lbs.

FILM MOUNTS

Clear Pocket Mounts

Buy 3, Get 1 FREE!

Same Style Only

Easy opening die cuts hold the film secure, while its thin profile requires minimum filing space. They are translucent for easy viewing.



All packages include 100 mounts each. Clear Pocket mounts are Buy 3, Get 1 FREE!

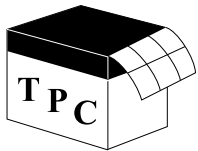

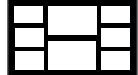
	Item Code	Description	Retail Price
	CP102U	Universal Select and cut Roll of 500 Strips of 2 mounts (1000 windows)	\$48.00
	CP1C	One Window Convertable	\$14.00
	CP2H	Two Window Horizontal	\$16.00
	CP4C	Four Window Convertable	\$21.90
	CP4H	Four Window Horizontal	\$21.90
	CP6H	Six Window Horizontal	\$24.00
	CP4H2V	Six Window - 4 Horizontal - 2 Vertical	\$24.60
	CP8C	Eight Window Horizontal	\$29.00
	CP8P	Eight Window Podo 2H #2 8H#0	\$31.00
	CP10C	Ten Window Convertable	\$33.90
	CP8H6V	Fourteen Window Horizontal -8 Horizontal -6 Vertical	\$40.00
	CP12H6V	Eighteen Window - 12 Horizontal - 6 Vertical	\$45.00
	CPTAG	Name Tag 100 / pkg	\$6.00

FILM MOUNTS

Open Window Mounts













Buy 2, Get 1 FREE!

Same Style Only

Easy opening die cuts hold the film secure, while its thin profile requires minimum filing space. They are translucent for easy viewing.



All packages include 100 mounts each. Open window mounts are Buy 2, Get 1 FREE!

	Item Code	Description	Retail Price
	W1H2	One Window Horizontal #2 Film	\$14.50
	W2H0	Two Window Horizontal #0 Film	\$15.50
	W2H2	Two Window Horizontal #2 Film	\$15.50
	W2H3	Two Window Horizontal #3 Film	\$15.50
	W4H0	Four Window Horizontal #0 Film	\$22.00
	W4H2	Four Window Horizontal #2 Film	\$22.00
	W4H2V2	Six Window Horizontal - 4 Horizontal - 2 Vertical # 2 Film	\$25.50
	W6H2	Six Window Horizontal #2 Film	\$25.50
	W8H2	Eight Window Horizontal #2 Film	\$32.00
	W8H6V2	Fourteen Window - 8 Horizontal - 6 Vertical #2 Film	\$40.00
	W12H6V2	Eighteen Window - 8 Horizontal - 6 Vertical - 4 BW #2 Film	\$52.00
	W10BW2	Ten Window BW #2 Film	\$39.00

FILM MOUNTS

Notched Mounts













Buy 2, Get 1 FREE!

Same Style Only

Easy opening die cuts hold the film secure, while its thin profile requires minimum filing space. They are translucent for easy viewing.



All packages include 100 mounts each. Notched mounts are Buy 2, Get 1 FREE!

	Item Code	Description	Retail Price
	N1H2	One Window Horizontal #2 Film	\$13.90
	N2H0	Two Window Horizontal #0 Film	\$14.50
	N2H2	Two Window Horizontal #2 Film	\$14.50
	N2H3	Two Window Horizontal #3 Film	\$15.50
	N4H0	Four Window Horizontal #0 Film	\$20.00
	N4H2	Four Window Horizontal #2 Film	\$20.00
	N4H2V2	Six Window - 4 Horizontal - 2 Vertical # 2 Film	\$24.50
	N6H2	Six Window Horizontal #2 Film	\$24.50
	N8H2	Eight Window Horizontal #2 Film	\$32.00
	N8H6V2	Fourteen Window - 8 Horizontal - 6 Vertical #2 Film	\$40.00
	N12H6V2	Eighteen Window - 8 Horizontal - 6 Vertical - 4 BW #2 Film	\$48.50
	N10BW2	Ten Window BW #2 Film	\$37.90
	N10BW3	Ten Window BW #3 Film	\$37.90

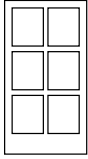

CLEAR POCKET MOUNT

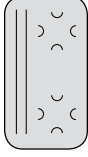

NOTCHED MOUNT

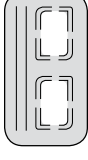

OPEN WINDOW MOUNT

FILM MOUNT CROSS REFERENCE CHART

TPC			CASTERM		RINN			FLOW		ADA	
POCKET	NOTCHED	WINDOW	POCKET	POCKET	POCKET	NOTCHED	WINDOW	NOTCHED	WINDOW	NOTCHED	WINDOW
CP102U			N.A.	20-0102							
CP8 PEDO			108 PEDO	N.A.				N.A.			N.A.
CP1C	N1H2	W1H2		20-1018	25-0178	30-6011	601-200G	23200		22004	22004
	N2H0	W2H0		20-1024	25-0811	30-4021	402-608G	23608		22616	22616
CP2H	N2H2	W2H2	102H	20-1020	25-0179	30-6021	602-203G	23203		22020	22020
	N2H3	W2H3		20-1023	25-0180	30-7021	702-206G	N.A.		22061	22061
	N4H0	W4H0		20-1044	25-0187	30-4040	404-609G	23609		22624	22624
CP4C	N4H2	W4H2	104C	20-1048	25-0181	30-6040	604-209G	23209		22103	22103
CP4H			104H	20-1040	25-0815	30-6045	6045-239G	23239		22152	22152
CP4H2V	N4H2V2	W4H2V2	106HV	20-1062	25-1061	30-6062	606-216G	23216		22202	22202
CP6H	N6H2	W6H2	106H	20-1060	25-0182	30-6061	606-215G	23215		22194	22194
CP8C	N8H2	W8H2	108C	20-1088	25-0825	30-6081	608-219G	23219		22251	22251
CP10C			110C	20-1108	N.A.	30-6101	610-220G	23220		22285	22285
CP8H6V	N8H6V2	W8H6V2	114HV	20-1142	25-0184	30-6141	614-225G	23225		22335	22335
CP12H6V	N12H6V2	W12H6V2	116-118HV	20-1182	25-0187	30-6180	618-268G	23228		22400	22400
CP10C	N10BW2	W10BW2	110C	20-1108	25-0821	30-2345	610-261G	23261		22558	22558
	N10BW3			N.A.	25-0820	30-3456	N.A.	23262		N.A.	N.A.
		W20BW2		80-0138	N.A.	30-4567	618-230G	N.A.		22574	22574

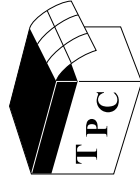

2H #2 6H #0



1H #2



2H #0



2H #2



2H #3



4H #0



4H #2



4H



4H 2V #2



6H #2



8H #2



10H #2



8H 6V #2



12H 6V #2

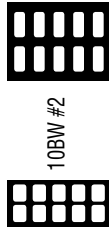

10BW #2



10BW #3

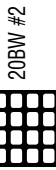

20BW #2



3-Way Syringe Push Ring



Part No.	Description	Retail
TPC3WAY-PR	3-way syringe W/ Tip	\$62.00
#52046	Replacment Cartridge (2pcs per pack)	\$11.00

- 360° tip rotation
- Accurate air and water control
- Autoclavable quick disconnect aerator tip
- Quick connect push ring.

Autoclavable 3-Way Syringe Tip



Part No.	Description	Retail
#M7500	Autoclavable 3-way syringe tip (box of 100) (compatible with DCI 3-way syringe)	\$250.00/Box

- syringe tip only
- box of 100

Shipping Dimensions: 6"L x 4"W x 2"H / 2 lbs.

Deluxe Autoclavable Valve

Autoclavable High Vacuum Valve – Short



Part No.	Description	Retail
#P2330	Deluxe Autoclavable high volume ejector–short	\$41.00
#P2166	Replacement Deluxe HVE lever & spool	\$12.00

- Autoclavable valve
- Finger tip lever control for on/off flow
- Swivel quick disconnect for 360° rotation
- Adapts to 1/2" ID vacuum tubing
- Disconnect at swivel for simple autoclaving
- Anodized aluminum one piece valve body construction with anodized aluminum swivel



Autoclavable High Vacuum Valve – Long



Part No.	Description	Retail
#P2335	Deluxe Autoclavable high volume ejector–long	\$41.00
#P2166	Replacement deluxe HVE lever & spool	\$12.00

- Autoclavable valve
- Ultra smooth lever control for on/off flow
- Swivel quick disconnect for 360° rotation
- Adapts to 1/2" ID vacuum tubing
- Disconnect at swivel for simple autoclaving
- Anodized aluminum one piece valve body construction with anodized aluminum swivel

Autoclavable Saliva Ejector Valve



Part No.	Description	Retail
#P2340	Deluxe Autoclavable saliva ejector valve	\$35.00
#P2169	Replacement deluxe saliva ejector lever & spool	\$12.00
#P2185	Replacement deluxe saliva ejector rubber tip <u>only</u> (5 pcs/Bag)	\$13.00/Bag

- Autoclavable valve
- Ultra smooth lever control for on/off flow
- Swivel quick disconnect for 360 degree rotation
- Disconnect at swivel for simple autoclaving
- Anodized aluminum one piece valve body construction with anodized aluminum swivel



Curing Bulb

- 12 Volt 75 Watt
- Power Light 100
- Replacement for PL100

#P201 \$ 39.00

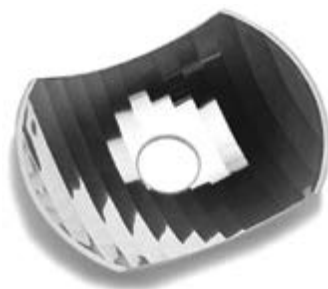

Operatory Light Reflector

- Quality coated glass
- No core charge
- Original factory OEM specifications
- Replacement reflector for Belmont®, LSM® and Celux lights

#P705 \$ 160.00



Scaler Tubing 25K without Connector

- 25KHz 3-wire handpiece assembly
- 7' length
- Only Compatible with TPC brand scalers

#S8001 \$ 110.00



Flow Control Valve

- Chrome plated brass
- Side Ported

#52007 \$ 22.00



Mini HP Control Block

- Mini control block for 3 handpieces
- Solid brass construction
- Extra mounting holes allow a variety of placements
- 10-32 threaded barbs
- Longest lasting inter-woven diaphragm
- High flow design

#52003 \$100.00

#52004 Diaphragm \$10.00



Water Bottle System

- 1000 ml Extra Heavy duty bottles
- Easy to read pressure gauge
- Pre-set integrated regulator
- Ideal for Anti-bacterial solutions
- Post clamp
- Will mount to vertical surface

#W5030 \$150.00

#W5040 - 1000 ml bottle only \$18.00



Flow Control Valve

- Chrome plated brass
- Side / Back Ported

#2600-RP-52007 \$ 16.50



Momentary Valve

- Chrome plated brass

#52008 \$ 14.00



On/Off 2-Way Valve

- Chrome plated brass

#52009 \$ 14.00



On / Off 3 Way Valve

- Chrome plated brass
- #52010 \$ 15.00



Check Valve

- Chrome plated brass
- #52019 \$ 10.00



Routing Valve

- Chrome plated brass
- #53014 \$ 15.00



Non-Retraction Water Relay Valve

- Chrome plated brass
 - Equivalent to DCI #7068
- #52011 \$ 35.00



4-hole Adapter, Metal

- Quality plated brass
- #52039 \$ 8.50



Plated Brass Nut 4-hole Midwest

- Brass extends HP thread life
 - Standard connector
- #52040 \$ 4.00



HP Tubing Adapter, 2 - hole HP to 4-hole Tubing

- Adapts 2 hole HP to 4-hole tubing
- #52041 \$ 39.00



HP Tubing Adapter, 4-hole HP to 2 -hole Tubing

- Adapts 4-hole HP to 2-hole tubing
- #52042 \$ 39.00



Stainless Steel Tray

- Premium quality stainless steel
 - Size 13F (9-3/4" x 13-1/2")
- #52026 \$ 42.00
#52027 Skid Pad \$3.16



Female Quick Disconnect

- Panel mount with auto shut-off
- 1/4" poly-flow rear connection
- Chrome plated brass
- 1/4" Coupler

#53012 \$ 15.00



Male Quick Disconnect w/ Shut-off

- With auto shut-off
- 1/4" poly-flow rear connection
- Chrome plated brass
- 1/8" Male QD

#53042 \$ 15.00



Male Quick Disconnect w/ Shut-off

- With auto shut-off
- 3/8" poly-flow rear connection
- Chrome plated brass
- 3/8" male QD

#53043 \$17.00



1/4" Coupler with shut off

- barb type
- Chrome plated brass
- Equivalent to DCI #0006

#53047 \$ 15.90



Foot Control, Wet/Dry

- Precision-touch disc foot control with wet/dry toggle
- Weighted for maximum stability
- Durable chrome steel dome
- Smooth, variable pressure control
- Non-skid foot pads

#53200 \$ 116.00

#53200-TS Toggle (only) \$1.98

#53121 Toggle assembly \$24.00



Foot Control, Shrouded

- Large stable base with shroud
- Precision-touch disc foot control
- Weighted for maximum stability
- Durable chrome steel dome
- Smooth, variable pressure control
- Non-skid foot pads

#53117 \$ 78.00



4 Hole HP Straight Asepsis Assembled

- Assembled with metal adapter / nut
- Silicone Jacket
- 5.5' length

#52036 \$33.00



Syringe Tubing

#52038 \$18.00

- 6' Silicone Jacket tubing



Air Electric Switch

- Normally open air switch
- 15 PSI activated Check this spec

#A800N-SW \$ 19.00

Parts



53016-S

53016-L

Disposable Amalgam Traps

- 53016-S-100 1 7/8" Clear
- 53016-L-100 2 1/8" Clear
- Clear trap pkg of 100

#53016-S-100 **\$45.00**

#53016-L-100 **\$45.00**



Solids Collector Canister

- Includes: Lid, Base, o-ring
- Bottom ported 2015 unit
- 2 1/8" trap

#53008

\$34.00



Solids Collector Canister

- Includes: Lid, Base, o-ring
- Side ported for 3550 unit
- 2 1/8" trap

#53008-R

\$34.00



Solids Collector Canister

- Includes: Lid, Base, o-ring
- Bottom ported, 2600 unit
- 1 7/8" trap

#53008-2600

\$30.00



Nylon Bushing

#LP-RI-S **\$22.00**

- OD 1 7/8"
- ID 1 3/8"



Nylon Bushing

#LP-PC-L **\$22.00**

- OD 1 7/8"
- ID 1 11/16"



Nylon Bushing

#L600N-ARM-RP24

\$22.00

- OD 1 7/8"
- ID 40mm
- L600N Arm Only



48" Light Post

#LP48 **\$180.00**

- 48" light post
- LP-PC-L included
- Optional: LP-RI-S



Swing Light Post Upper part

#LP-26 **\$218.00**

- Upper post for LP100
-



Belmont Radius Bracket (Unit)

#2400-BRKT-BEL

\$478.00

- Fits: Bel 20, Bel 50

Belmont Rear Radius Bracket (Oblong Shape)

#2450-BRKT-BEL-N **\$ 198.00**

- Bel 50 Rear Mount

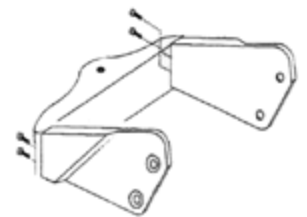

Belmont Rear Radius Bracket (U shape)

#2450-BRKT-BEL **\$218.00**



Chair Adaptor

#BELBRKT **\$ 198.00**

- Belmont Chair Bracket
- Fits Bel 20 and 50 chairs
- Reversible left or right



Chair Adaptor

#TPCBRKT **\$ 290**

- TPC chair bracket
- Fits Mirage 1-2, Laguna 2.0
- Reversible left or right



Chair Adaptor

#TPCRDSBKT **\$ 400**

- TPC swing bracket
- Fits Mirage 1.0 - 2.0
- Fits LP100, LP105 Post



Chair Adaptor

#L2000-BKT **\$ 290**

- Laguna chair bracket
- Fits Laguna 1.0 only

Parts PC2630 / PC 2930



Waste Container

- Fits: PC-2630,2635,3600
OMC2375-CVSL
 - Includes Cap and jar
 - Color: Blue
- #PC-2630N-SWC
\$ 14.00



Water Bottle

- Water Bottle (Clear)
 - Fits: PC2630, 2635, 3600,
OMC2375, 2930
 - 700 ml
- #PC-2630N-CWB
\$ 10.00



H.P. holder Automatic

- Panel Mount HP holder
 - Fits: PC2635 only
 - Plastic w/ Metal base
 - Includes: Base, Holder
- #PCP-N-RP1
\$ 26.00



H.P. holder

- Panel Mount HP holder
 - Fits: PC2630 only
 - Plastic
- #PC-2630N-RP11
\$ 9.00



On / Off 3 Way Valve

- Chrome plated brass
 - Water bottle on/off
- #52010 \$ 15.00



Routing Valve

- Chrome plated brass
 - H.P Selector Valve
- #53014 \$ 15.00



On/Off 2-Way Valve

- Chrome plated brass
 - Suction on / off valve
- #52009 \$ 14.00



Flow Control Valve

- Chrome plated brass
 - Water Adjustment for PC
2630, 2930
- #52007 \$ 22.00



1/4" Coupler with shut off

- barb type
 - Chrome plated brass
 - Equivalent to DCI #0006
- #53047 \$ 15.90



4 Hole H.P. Tubing

- With metal adapter / nut
 - Silicone Jacket
 - 5.5' length
- #52036 \$27.00



Water Relay Block

- 2 position water relay block
- #PC--P2023 \$39.00



Foot Control, Shrouded

- Durable chrome steel dome
 - Smooth, variable pressure control
 - Non-skid foot pads
- #53117 \$ 78.00



Syringe Tubing

- 6' Silicone Jacket tubing
- #52038 \$18.00



Power Switch

- Main power switch
- #PCN-P5001 \$17.00

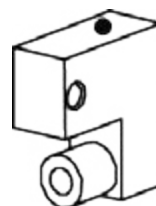

110V Pressure relief valve

- 110V Pressure relief valve
- #PC-P2031 \$60.00



Air Venturi Valve

- S.E. Air Venturi Valve
- #PC-2630-P001 \$100.00

Parts MC3600CV-SL



Waste Container

- Fits: PC-2630,2635,3600
OMC2375-CVSL
 - Includes Cap and jar
 - Color: Blue
- #PC-2630N-SWC
\$ 14.00



Water Bottle

- Water Bottle (Clear)
 - Fits: PC2630, 2635, 3600,
OMC2375, 2930
 - 700 ml
- #PC-2630N-CWB
\$ 10.00

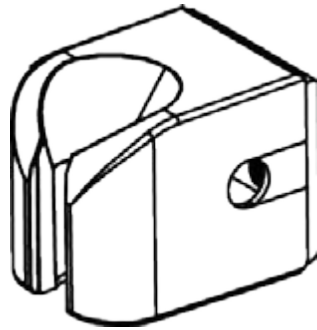

H.P. holder Automatic

- Bar Mount HP holder
 - Fits: MC3600CV/SL
 - Plastic w/ Metal base
 - Includes: Base, Holder
- #MC3600-RP-32
\$ 40.00
#MC3600-RP-30 (Valve)
\$ 11.00

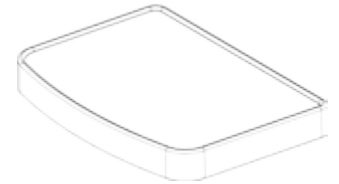

Top Cover

- Plastic top cover
 - Fits: MC3600/3600CV-SL
- #MC3600-RP-1
\$ 80.00



On / Off 3 Way Valve

- Chrome plated brass
 - Water bottle on/off
- #52010 \$ 15.00



Routing Valve

- Chrome plated brass
 - H.P Selector Valve
- #53014 \$ 15.00



On/Off 2-Way Valve

- Chrome plated brass
 - Suction on / off valve
- #52009 \$ 14.00



Flow Control Valve

- Chrome plated brass
 - Water Adjustment for PC
2630, 2930
- #52007 \$ 22.00



1/4" Coupler with shut off

- barb type
 - Chrome plated brass
 - Equivalent to DCI #0006
- #53047 \$ 15.90



4 Hole H.P. Tubing

- With metal adapter / nut
 - Silicone Jacket
 - 5.5' length
- #52036 \$27.00



Water Relay Block

- 2 position water relay block
- #PC--P2023 \$39.00

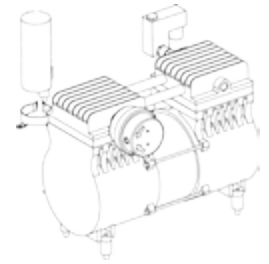

110V Main Motor

- 110Vac motor with start cap
 - Quite operation
 - Included mounts, air filter
- #PCP-2530-RP01 \$ 600.00



Syringe Tubing

- 6' Silicone Jacket tubing
- #52038 \$18.00



Power Switch

- Main power switch
- #PCN-P5001 \$17.00

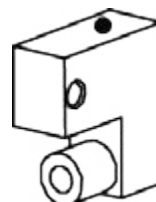

110V Pressure relief valve

- 110V Pressure relief valve
- #PC-P2031 \$60.00

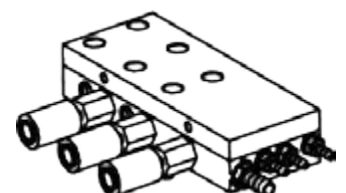

Tri Block

- 3 position Tri Block Complete
- #MC3600-RP-50 \$100.00

Parts OMC2375CV



Waste Container

- Fits: PC-2630,2635,3600
OMC2375-CVSL
 - Includes Cap and jar
 - Color: Blue
- #PC-2630N-SWC
\$ 14.00



Water Bottle

- Water Bottle (Clear)
 - Fits: PC2630, 2635, 3600,
OMC2375, 2930
 - 700 ml
- #PC-2630N-CWB
\$ 10.00



H.P. holder Shell

- Bar Mount HP holder
 - Fits: OMC2375CVSL
 - Plastic Shell only
- #OMC-RP-12-C
\$ 16.00

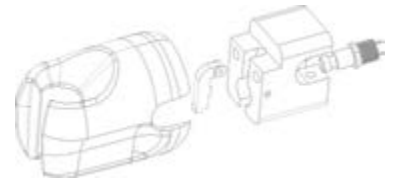

H.P. Holder Complete

- Bar Mount HP holder
 - Fits: OMC2375CVSL
 - Includes: Shell, Block, Valve
- #OMC-RP-12
\$ 42.00

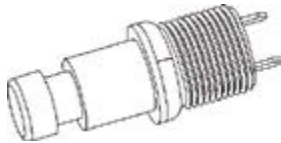

N.C. Valve

- Normally Closed
 - HP activation valve
- #OMC-RP-13 **\$ 11.00**



Routing Valve

- Chrome plated brass
 - H.P Selector Valve
- #53014 **\$ 15.00**



On/Off 2-Way Valve

- Chrome plated brass
 - Suction on / off valve
- #52009 **\$ 14.00**



Flow Control Valve

- Chrome plated brass
 - Water Adjustment for PC
2630, 2930
- #52007 **\$ 22.00**

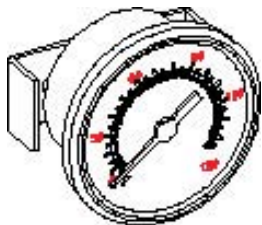

Pressure Gauge

- OMC Cabinet Pressure Gauge
 - Front Panel Mounted
 - Bracket not included
- #53047 **\$ 15.90**



4 Hole H.P. Tubing

- With metal adapter / nut
 - Silicone Jacket
 - 5.5' length
- #52036 **\$ 27.00**



Water Relay Block

- 2 position water relay block
- #PC--P2023 **\$ 39.00**

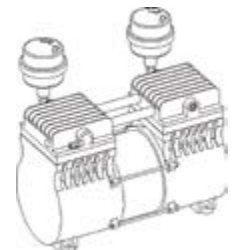

110V Main Suction Motor

- 110Vac motor with start cap
 - Quite operation
 - Included mounts, air filter
- #OMC-2375CV-MTR-1
\$ \$600.00



Syringe Tubing

- 6' Silicone Jacket tubing
- #52038 **\$ 18.00**



Power Switch

- Main power switch
- #PCN-P5001 **\$ 17.00**

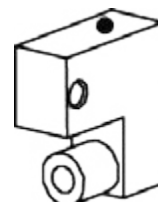

110V Pressure relief valve

- 110V Pressure relief valve
- #PC-P2031 **\$ 60.00**

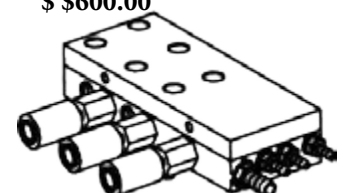

Tri Block

- 3 position Tri Block Complete
- # OMC-RP-17N **\$ 100.00**

Custom Umbilical Lengths / Utility Center

2000 / 2015 Umbilical

- 1 (6 X 4) MM Air "Yellow"
 - 1 (6 X 4) MM Water "Blue"
 - 4 (4 X 2.7mm)
 - Yellow
 - Grey
 - Purple
 - Red
 - 1 (5/8") Drain Line
 - 1 (5/8") Cuspidor Drain 2000 unit
 - 1 (2") Umbilical
 - No Electrical / Low Voltage
- #2015-UMB-FT **\$ 50.00**
 #2015-UMB-10 **\$300.00** 10' length

3500 Umbilical

- 1 (6X4) MM Air "Black"
 - 9 (4 X 2.7mm)
 - Yellow
 - Grey
 - Purple
 - Red
 - Green
 - Blue
 - Maroon
 - Black (spare)
 - Red (spare)
 - No Low Voltage
- #3500-UMB-FT **\$50.00**
 #3500-UMB-10 **\$300.00** 10' length

3550 Umbilical

- 1 (6X4)mm Air "Yellow"
 - 1/2" Sprial Loc Tubing
 - Syringe tubing.
- #3550-UMB **\$130.00** 6' length
 #3550-UMB-10 **\$250.00**
 10' length



MC500 / 501 Umbilical

- 1 6X4MM Air "Black "
 - (1 1/2") Umbilical
 - 8 4 X 2.7mm
 - Yellow
 - Grey
 - Red
 - Green
 - Blue
 - Maroon
 - Black (spare)
 - Red (spare)
 - Purple (spare)
 - 1/2" Sprial Lock Suction
 MC501 only Add
 \$2.62 per ft
 - Low Voltage
- #MC500-UMB-FT **\$ 50.00**

OMC2375 Umbilical

- 1 6X4MM Air "Yellow"
 - 1 (1 1/2") Umbilical
 - 8 4 X 2.7mm
 - Yellow
 - Grey
 - Clear
 - 5/8" Sprial Lock Sction
 - No Electrical
- #OMC2375-UMB-FT **\$ 50.00**
 #OMC2375-UMB-10 **\$ 300.00**

MS3000 / MR4000

- 1 6X4mm Air "Black"
 - 8 4 X 2.7mm
 - Yellow
 - Grey
 - Red
 - Green
 - Blue
 - Maroon
 - Black (spare)
 - Red (spare)
 - Purple (Spare)
 - No Low Voltage
- #3000-UMB-FT **\$50.00**

Junction Box

- 12.5" X 12.5"
 - Metal frame
 - Plastic top cover
- #53120 **\$130.00**



Master Shut-Off Valve

- Includes air / water valved
 - 3/8" compression tube
 - Includes pressure regulator
 - Includes pressure guage
- #53119 **\$230.00**



Rebulid Kit for 53119

- Diaphram
 - Spring
 - Plunger
- #53199 **\$13.00**



40 micron filter

- Use for air and water
 - 40 micron filter element
- #53107 **\$3.90**



Raw Suction Tubing per Ft.

Part Number	Description	Price per Ft
53096	1/2 Grey Sprial Lock Tubing	\$3.30 Per Ft
53093	5/8" Clear Sprial Lock Tubing	\$3.30 Per Ft
53085	5/8" Grey Sprial Lock Tubing	\$3.30 Per Ft
53021	2" Umbilical Tubing	\$7.00 Per Ft
2000-HVETubing	1/2" Smooth HVE tubing	\$3.90 Per Ft
2000-SETubing	Saliva Ejector Tubing	\$1.30 per Ft

Corporate Staff Contacts

Customer Care (8:00 a.m. – 5 p.m. PST)
Customer Service Fax Orders

1-626-810-4337
1-626-810-4245



Scott Beckley
Vice President Sales
sbeckley@tpcdental.com



Charlie Nguyen
Handpiece Specialist
charles@tpcdental.com



Mike Carlone
Service / Repair Manager
mcarlone@tpcdental.com



Holly Han
Shipping Manager
holly@tpcdental.com



Ryan Kong
Customer Service
customerservice@tpcdental.com

Jeff Liscano
Technical Support
jliscano@tpcdental.com

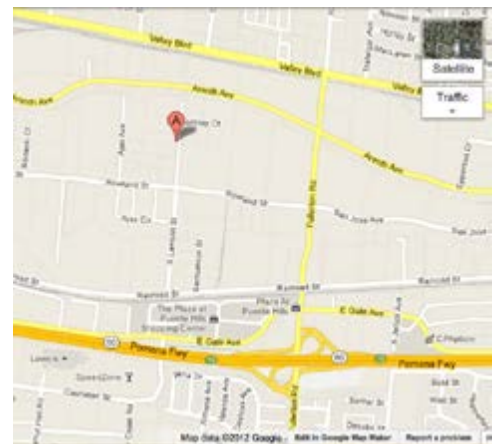

851 S. Lawson St. • City of Industry, CA
91748
Tel. (800) 560-8222 • Fax (626) 810-4245

TPC Standard Vinyl Upholstery Color Chart



Desert Rose
LK-34



Grey Teal
LK-49



Taupe
LK-08



Sand
LK-03



Black
LK-72



Atlantis
LK-59



Cobalt
LK-31



Greystone
LK-11

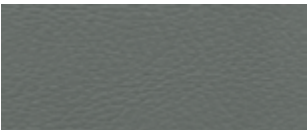

Stormy
LK-04

Morbern Allante FRee Standard Vinyl Color Seletion

Meets CA TB 117-2013 (Section E) Standard

AF colors are subject to upcharge for Laguna Upholstery

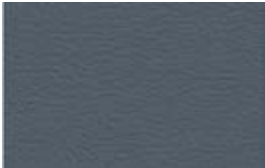

AF-905
Province Blue



AF-916
Red Truffle



AF-918
Ink Black



AF-920
Galaxy



AF-911
Taupe Fawn

Upgraded Naugasoft Upholstery Color Selection

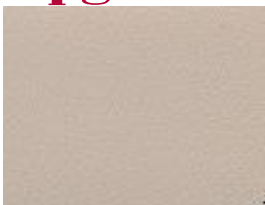

PR 35 Fawn



PR 36 Cabernet



PR 37 Feather

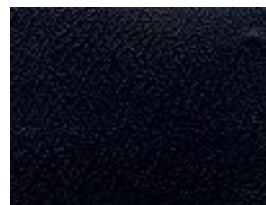

PR 40 Black Satin



PR 46 Blue Fog



PR 49 Deep Sea



PR 50 Lake Louise

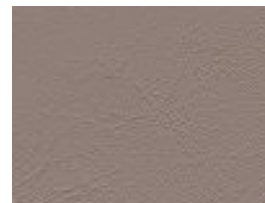

PR 51 Cocoa



PR 52 Saddle



PR 54 Mallard Blue

Description	Models Covered	Stocked (Above Colors)	Non-Stocked
Dental Chair Naugasoft Upholstery upgrade	(PC1000, PC5000)	\$330	\$490
Doctor Stool Naugasoft Upholstery upgrade	(DR1102, DR7000)	\$100	\$148
Hygiene Stool Naugasoft Upholstery upgrade	(HY5107)	\$120	\$194
Assistant Stool Naugasoft Upholstery upgrade	(AS1101)	\$120	\$170
X-Ray Chair Naugasoft Upholstery upgrade	(XR-6101)	\$280	\$340

Naugasoft Upholstery Upgrade Charges

www.tpedental.com



TPC Advanced Technology, Inc.

851 S. Lawson St. • City of Industry, CA 91748

Tel. (800) 560-8222 • Fax (626) 810-4245